

GB

705

C6S6

DEPARTMENT OF THE INTERIOR  
UNITED STATES GEOLOGICAL SURVEY

GEORGE OTIS SMITH, DIRECTOR

WATER-SUPPLY PAPER 240

GEOLOGY AND WATER RESOURCES  
OF THE  
SAN LUIS VALLEY, COLORADO

BY

C. E. SIEBENTHAL



WASHINGTON  
GOVERNMENT PRINTING OFFICE  
1910



Class QB705

Book .C656

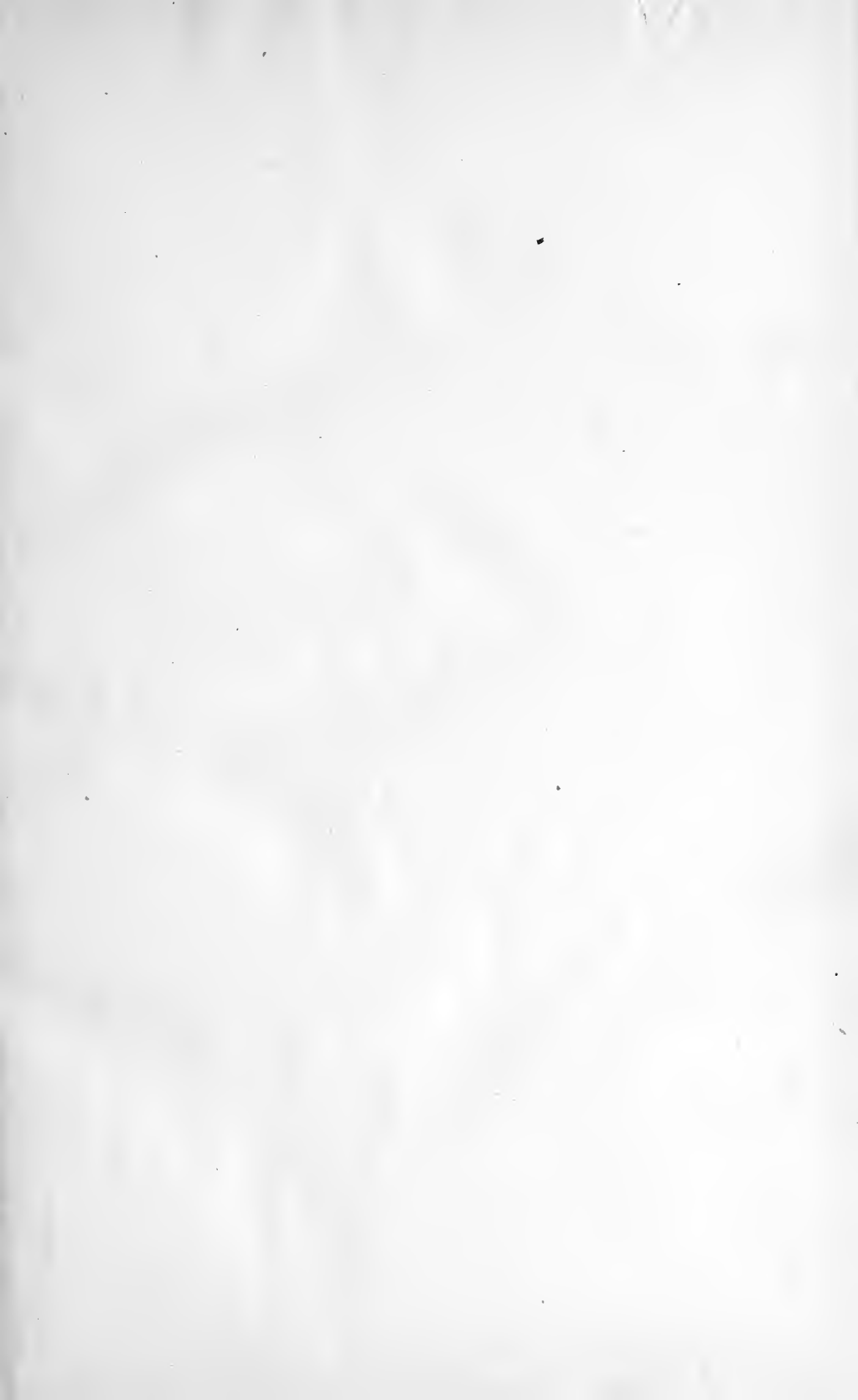







5  
DEPARTMENT OF THE INTERIOR  
UNITED STATES GEOLOGICAL SURVEY

GEORGE OTIS SMITH, DIRECTOR

314  

---

WATER-SUPPLY PAPER 240

---

GEOLOGY AND WATER RESOURCES

OF THE

69  

---

792  
SAN LUIS VALLEY, COLORADO

BY

C. E. SIEBENTHAL



WASHINGTON  
GOVERNMENT PRINTING OFFICE

1910

Copy 2

GE 70-1  
C 650

NOV 9 1910  
A. W. D.



# CONTENTS.

	Page.
Introduction.....	7
Scope of report.....	7
Date of report.....	7
Acknowledgments.....	7
Literature.....	8
Geography.....	9
Location and character.....	9
Topography.....	10
Drainage.....	12
Hydrography.....	12
Stream gagings.....	12
Relation of the San Luis Valley irrigation to the volume of the Rio Grande in New Mexico.....	15
Reservoir sites.....	18
Irrigation.....	19
Canals.....	19
Pumping the "sub.".....	20
Pumping the underflow.....	20
Canvas flumes.....	21
Climate.....	22
Agriculture.....	25
Order of settlement.....	25
Native vegetation.....	26
Cultivated crops.....	26
Methods of irrigation.....	27
Geology.....	29
Introductory statement.....	29
The west ranges.....	29
Alamosa Creek valley.....	30
Cat Creek valley.....	31
Rock Creek valley.....	31
West of Monte Vista.....	32
Vicinity of Sauguache.....	32
Age of rocks.....	32
Glaciation.....	33
The east ranges.....	34
Stratigraphy and structure.....	34
Glaciation.....	37
San Luis Hills.....	37
The valley.....	39
Santa Fe formation.....	39
Alamosa formation.....	40
Quaternary deposits.....	47
Sand dunes.....	47
Alluvial fans.....	47
Alluvium.....	49
Alkali lake deposits.....	50
Geologic history of the San Luis Valley.....	50

Underground waters.....	54
General considerations.....	54
Prerequisite features of artesian system.....	54
Application to the San Luis Valley.....	54
Source of the artesian water.....	55
Adequacy and permanency of supply.....	56
Capacity.....	56
Flowing wells.....	57
Marginal region.....	57
Alamosa and vicinity.....	57
Henry station and vicinity.....	60
Fountain neighborhood.....	62
La Jara and vicinity.....	63
Sanford and vicinity.....	66
Vicinity of Los Sauces.....	67
Parma and vicinity.....	68
Monte Vista and vicinity.....	69
Center and vicinity.....	71
Lockett and vicinity.....	73
Veteran neighborhood.....	74
Swede Corners and vicinity.....	75
Warner neighborhood.....	76
Moffat and vicinity.....	76
Mirage and vicinity.....	78
San Isabel and vicinity.....	78
Baca grant.....	79
Medano ranch.....	80
Calkins ranch.....	80
Central or Mosca-Hooper region.....	81
Occurrence of gas and colored water.....	81
Mosca and vicinity.....	82
Hooper and vicinity.....	85
Kinney ranch.....	88
Jacobs ranch.....	89
San Luis village.....	90
Nonflowing wells.....	92
Antonito.....	92
Manassa and vicinity.....	93
Capulin and vicinity.....	95
Bowen School and vicinity.....	97
Monte Vista and vicinity.....	98
Del Norte.....	98
La Garita and vicinity.....	99
Saugauche and vicinity.....	99
Villa Grove and vicinity.....	99
Crestone and vicinity.....	100
Baldy station and vicinity.....	100
Fort Garland and vicinity.....	101
Springs.....	101
McIntire Springs.....	101
Dexter Spring.....	102
Other springs along Conejos River.....	102
Spring Creek.....	102

Underground waters—Continued.	Page.
Springs—Continued.	
Russell Springs.....	102
Hunt Springs.....	103
Antelope Springs.....	103
Medano Springs.....	103
Washington Springs.....	103
Chamberlain Hot Springs.....	103
Valley View Hot Springs.....	104
Hot Creek Springs.....	104
Characteristics of the artesian basin.....	105
Grouping of wells.....	105
Variations in flow.....	105
Seasonal variations.....	105
Gradual failure of wells.....	105
Sudden failure of wells.....	107
Irregularities in flow from the same aquifer.....	107
Variation in temperature.....	108
Vertical variation.....	108
Seasonal variation.....	110
Quality of the water.....	111
Uses of the water.....	115
Wells.....	116
Well drilling.....	116
Approximate measurement of flowing wells.....	118
From filled pipes.....	118
From partly filled pipes.....	122
Index.....	125

## ILLUSTRATIONS.

	Page.
PLATE I. ✓ Map of San Luis Valley.....	In pocket.
II. ✓ A, Blanca Peak from the southwest; B, Cirque at the head of Rock Creek.....	10
III. ✓ A, Lava-capped slope dipping beneath the valley west of Antonito; B, Bluff of Santa Fe formation on Alamosa Creek.....	30
IV. ✓ A, "Painted Rock" Bluff on Cat Creek; B, Soda Lake.....	32
V. ✓ Willow Creek Park.....	34
VI. ✓ Synclinal valley of upper Willow Creek.....	36
VII. ✓ A, Bucher well; B, Hansen Bluff, showing stratigraphy of Alamosa formation.....	40
VIII. ✓ Typical sand dune on Medano ranch.....	48
IX. ✓ Plat of Alamosa, showing location of wells.....	58
X. ✓ A, Six-inch well on Empire Farm; B, Kinch well.....	60
XI. ✓ A, Espinosa well, bored in 1888; B, Navin well, bored in 1903.....	74
XII. ✓ A, Clark's gas well and storage tank; B, Hunt Springs.....	88
XIII. ✓ A, Chamberlain Hot Springs; B, McIntire Springs.....	102
FIGURE 1. Outline map of Colorado, showing location of San Luis Valley.....	9
2. Plan of pumping plant, showing subterranean gallery.....	21
3. Ideal cross section of San Luis Valley from foot of Blanca Peak to foot of Conejos Range.....	45
4. Diagram to illustrate the structure of the artesian basin and the alluvial slope and to indicate the relation of the glacial moraines to the latter.....	46
5. Plat of La Jara, showing location of wells.....	64
6. Plat of Richfield, showing location of wells.....	65
7. Plat of Sanford, showing location of wells.....	66
8. Plat of Monte Vista, showing location of wells.....	70
9. Plat of Center, showing location of wells.....	72
10. Plat of Moffat, showing location of wells.....	77
11. Plat of Mosca, showing location of wells.....	83
12. Plat of Hooper, showing location of wells.....	86
13. Plat of San Luis, showing location of wells.....	90
14. Diagram illustrating flow from vertical and horizontal pipes.....	119
15. Diagram illustrating method of measuring partly filled pipes.....	123

# GEOLOGY AND WATER RESOURCES OF THE SAN LUIS VALLEY, COLORADO.

---

By C. E. SIEBENTHAL.

---

## INTRODUCTION.

### SCOPE OF REPORT.

In the preparation of this report three objects have been kept in view:

1. To present such a summary of the geologic conclusions of previous workers together with the observations of the writer as would give to the reader a comprehensive view of the geology of the San Luis Valley and the surrounding rim and enable him to understand the relation of the artesian basin to the geologic structure.

2. To give a description of the artesian basin, its development, and its prospects.

3. Finally, to make accessible to the reader such information in regard to climate, agriculture, irrigation, and water resources as is available and of general interest.

### DATE OF REPORT.

The field work in the San Luis Valley was completed in 1904, and the report thereon was prepared in 1906. Untoward circumstances have intervened to prevent the publication of the report until the present. It is to be understood, therefore, that the description of the development and prospects of the artesian basin refers to conditions at the close of field work in 1904.

### ACKNOWLEDGMENTS.

The writer wishes to acknowledge the cordial cooperation of the citizens generally and in particular that of the following persons, without whose valuable assistance this report would have materially suffered: Hon. W. H. Adams, Hon. E. L. Myers, Hon. J. H. Williams, Messrs. G. H. Adams, Frank Beckwith, M. D. Blakey, M. B. Colt, Oscar Fountain, A. A. Goodall, William Hansen, W. R. Hapney,

D. W. Holman, H. J. Johnson, Stephen Kinney, Horace Means, W. O. Meier, A. L. Moss, D. E. Newcomb, George Newsom, Prof. L. A. Norland, A. Shellabarger, R. W. Shellabarger, Charles Speiser, L. B. Sylvester, H. C. Warner, G. M. Whitead, and others, and especially the officials of the Monte Vista Land Company, the Parma Land Company, and the various well drillers in the valley.

Obligations are also due to Prof. W. A. Converse, of the Dearborn Drug and Chemical Company, of Chicago, Ill., for analyses of various well waters, duly credited in the table of analyses, several made especially for this report; to Dr. W. P. Headden, of the Colorado Agricultural College, for various analyses of San Luis waters, also credited in the report; and to Mr. P. F. Lund, of the Denver and Rio Grande Railroad, for data concerning various wells sunk by that company in the valley.

#### LITERATURE.

The following references comprise the important literature relating to the San Luis Valley:

##### GEOLOGY.

- BAGG, R. M. Some copper deposits in the Sangre de Cristo Range, Colorado. *Econ. Geology*, vol. 3, 1908, pp. 739-749.
- EMMONS, S. F. Orographic movements in the Rocky Mountains. *Bull. Geol. Soc. America*, vol. 1, pp. 245-286.
- ENDLICH, F. M. *Ann. Rept. U. S. Geol. and Geog. Survey Terr. for 1873*, pp. 323-351; for 1875, pp. 105-175.
- GUNTHER, C. G. Gold deposits of Plomo, San Luis Park, Colorado. *Econ. Geology*, vol. 1, pp. 143-154.
- HAYDEN, F. V. *Ann. Rept. U. S. Geol. and Geog. Survey Terr. for 1869*, pp. 72-76.
- HILLS, R. C. Orographic and structural features of Rocky Mountain geology. *Proc. Colorado Sci. Soc.*, vol. 3, pp. 362-458.
- Walsenburg (No. 68) and Spanish Peaks (No. 71) folios, *Geol. Atlas U. S.*, U. S. Geol. Survey.
- SIEBENTHAL, C. E. Notes on glaciation in the Sangre de Cristo Range, Colorado. *Jour. Geology*, vol. 15, 1907, pp. 15-22.
- The San Luis Valley, Colorado. *Science*, new series, vol. 31, no. 802 (May 31, 1910), pp. 744-746.
- STEVENSON, J. J. *U. S. Geog. Surveys W. 100th Mer.*, vol. 3, pp. 315 et seq.; also Supplement, pp. 313-319.
- VAN DIEST, E. C. and P. H. Notes on the geology of the western slope of the Sangre de Cristo Range. *Proc. Colorado Sci. Soc.*, vol. 5, pp. 76-80.

##### IRRIGATION AND HYDROLOGY.

- CARPENTER, L. G. Artesian wells of Colorado and their relation to irrigation. *Bull. Colorado Agr. Coll. Exper. Sta.*, No. 16.
- Report to the Secretary of Agriculture, on artesian wells. *Sen. Ex. Doc. No. 222*, 51st Cong., 1st sess., pp. 218-225, 230-231.
- GREEN, J. S. *Ann. Rept. Colorado State Engineer, 1887-8*, p. 303.

- HEADEN, W. P. Significance of silicic acid in waters of mountain streams. *Am. Jour. Sci.*, 4th ser., vol. 16, 1903, pp. 169-184.
- The brown artesian waters of Costilla County, Colorado. *Am. Jour. Sci.*, 4th ser., vol. 27, 1909, pp. 305-315.
- HINTON, RICHARD J. Report on irrigation and the cultivation of the soil thereby. *Sen. Ex. Doc. No. 41, 52d Cong., 1st sess.*, pt. 1, pp. 151-154.
- HOLMES, J. GARNETT. Soil survey of the San Luis Valley, Colorado. *Field Operations Bur. Soils, U. S. Dept. Agr.*, 1903, pp. 1099-1119.
- MAXWELL, J. P. *Ann. Rept. Colorado State Engineer, 1889-90*, pp. 42 and 43.
- NEWELL, F. H. *Eleventh Census, volume on Agriculture by irrigation*, pp. 98-100

## GEOGRAPHY.

## LOCATION AND CHARACTER.

The San Luis Valley, having an area comparable to the State of Connecticut, lies in the south-central part of Colorado (fig. 1), with a

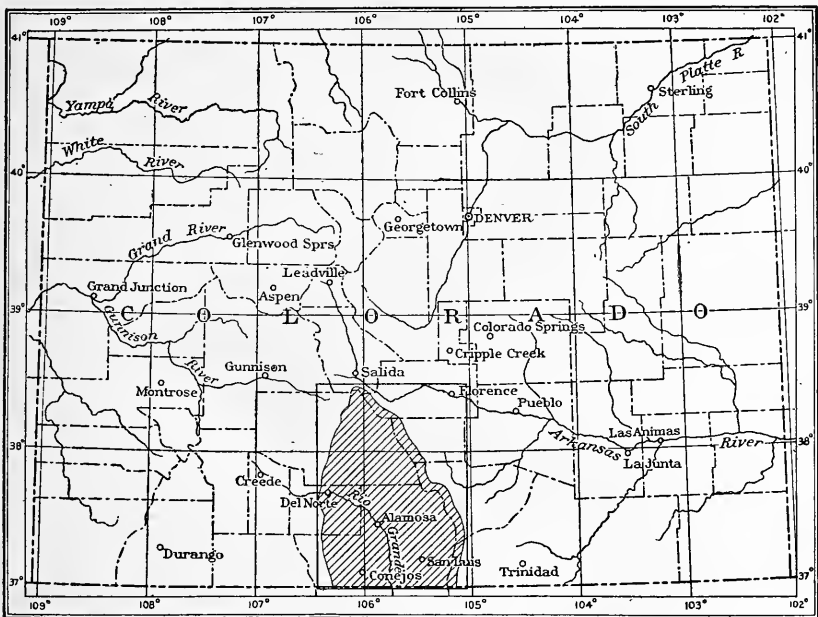

FIGURE 1.—Outline map of Colorado, showing location of San Luis Valley.

narrowed southern end reaching into New Mexico about 15 miles. The whole length of the valley from north to south is about 150 miles and its greatest width about 50 miles. The San Luis Hills, a series of basalt-capped table-topped mountains extending from Antonito in the direction of Fort Garland, separate the valley into two portions. It is with the northern part, containing the artesian basin, that we have to do. This portion of the valley is limited on the east by the majestic Sangre de Cristo Range, on the west by the Sawatch and Conejos ranges, and on the south by the San Luis Hills.

## TOPOGRAPHY.

The accompanying topographic map is based on Hayden's geologic and topographic atlas of Colorado for the mountainous region, with the addition of certain details near the margin of the valley, but the valley portion is compiled by the writer from sketches in the field, aneroid readings, and the various railway and ditch profiles. A study of the map will give a very clear notion of the topography. The salient features are the bold Sangre de Cristo Range and the less abrupt Culebra Range on the east, the gentler eastward-sloping Sawatch and Conejos ranges on the west, the flat-topped San Luis Hills on the south, and the almost flat surface of the valley itself. As the map shows, the trough of the valley lies far east of the median axis—close under the Sangre de Cristo, in fact. From the trough the country rises to the foothills, more steeply eastward, very gently westward, at first not more than 3 to 6 feet to the mile, but gradually increasing until near the foothills the rise is quite perceptible to the eye. The extreme flatness of the valley is shown by the great distances for which the canals are constructed along straight lines. The Prairie ditch and the laterals of the Farmer's Union canal and the Del Norte canal run from 10 to 25 miles on straight east and west lines, with branches north and south at right angles.

So nearly level is the valley floor that its essential character entirely escapes one traveling over it, and it is only when brought out by a topographic map that it becomes clear. In such a map, however, the alluvial-fan structure of the valley floor is strikingly manifest. Each stream descending from the steeper slopes of the mountains to the valley has deposited its spreading fan of gravel and sand. Around the west and south sides of Blanca Peak (as shown in Pl. II, *A*) these alluvial fans are especially prominent. They are so close together that they coalesce along their lateral margins to form a steep, gravelly alluvial slope skirting the foot of the mountain. The streams coming down from the west range, having a much lower gradient, can carry neither such heavy material nor so much of it, and as a consequence have built up much flatter fans, though the form of the fans is no doubt chiefly due to the fact that, except for the surface veneer of gravel and sand, they were deposited in water, as shown by the continuity of the clay and sand beds of the Alamosa formation. However, La Jara, Alamosa, and Cat creeks have built up pronounced fan deltas. But the map shows at a glance that the Rio Grande has built the most extensive fan of all and, for the reason given above, the flattest. It is also clear that the trough of the valley lies so far to the east because the encroaching fan has pushed it there, and that the sluggish character of San Luis Creek has resulted from the filling in of its lower course by the same agency. Conejos River has built a long fan partly confined between the Mogotes Mountains and the





4. BLANCA PEAK FROM THE SOUTHWEST.  
Showing alluvial slopes and characteristic vegetation.



B. CIRQUE AT HEAD OF ROCK CREEK.  
Showing character of gathering grounds in the western ranges of streams delivering water to the artesian system.



San Luis Hills, and partly extending south of the San Luis Hills into New Mexico, and must have discharged or at least sent distributaries at times to the south of the San Luis Hills. Saguache Creek has likewise a fan delta, but one rather poorly developed. San Luis Creek, taking its source in Poncha Pass not much above the level of the valley itself, naturally could develop no fan.

The streams in the valley proper have cut their valleys to various depths, but all are shallow. The bank of the Rio Grande at Monte Vista, where the oldest terrace comes to the river, is 20 or 30 feet high. At Alamosa the bank is from 8 to 12 feet high. The other streams have banks varying from a few inches to 4 or 5 feet high.

At different places in the valley there are bluffs which are not now adjacent to streams but which represent the margins of abandoned courses of the streams in their wanderings over the alluvial fans and slopes after the emptying of the lake which filled the valley during the deposition of the Alamosa formation. Most of these are shown on the map. One passes through Sanford, two are near Henry station, and one northwest of Hooper. They vary in height, but are mostly not far from 10 feet.

Stretching from Washington Springs south to the mouth of Trinchera Creek is a bluff bank which culminates opposite the Hansen ranch and has for that reason been called the Hansen Bluff. It here reaches a height above the Rio Grande of 60 feet, as shown in Plate VII, *B*. The level country stretching away eastward from its top represents the level of the valley bottom at the time when the water cut down the divide in the San Luis Hills and began to drain the lake that originally occupied the center of the valley. The original course of the river was probably somewhat west of its present course, but the alluvial fans of the streams on the west side of the valley have continually pushed it eastward and caused it to undercut the bluff.

The following elevations have been compiled from various sources, railway levels, ditch levels, and aneroid readings:

*Elevation of points in San Luis Valley.*

	Feet.		Feet.		Feet.
Alamosa.....	7, 536	Crestone.....	7, 851	Henry.....	7, 548
Alder.....	8, 525	Davenport.....	8, 158	Hooper.....	7, 555
Antonito.....	7, 878	Del Norte.....	7, 870	Hot Springs.....	7, 746
Baldy.....	7, 609	Dune.....	7, 538	Hunt Springs.....	7, 670
Blanca.....	8, 405	Freedom P. O.		La Garita P. O....	7, 900
Blanca Peak.....	<sup>a</sup> 14, 390	(Morgan).....	7, 630	La Garita ranch	
Bowen S. H.....	7, 660	Garnett P. O.....	7, 598	house.....	7, 630
Carnero.....	7, 700	Garland.....	7, 926	La Garita station..	7, 540
Capulin.....	7, 800	Granger.....	8, 040	La Jara.....	7, 599
Center.....	7, 630	Hayes.....	7, 527	La Veta Pass.....	9, 232
Creede.....	8, 842	Haywood.....	7, 746	Lockett P. O.....	7, 575

<sup>a</sup>This is the elevation given in Gannett's "Dictionary of altitudes" (Bull. U. S. Geol. Survey No. 274, 1906, p. 141). The elevation given on the map (14,490±) was determined by the Hayden Survey; Gannett's figure was recalculated from that.

*Elevation of points in San Luis Valley—Continued.*

	Feet.		Feet.		Feet.
Manassa.....	7, 660	Poncha Pass.....	9, 038	South Fork.....	8, 178
McGinty.....	7, 542	Romeo.....	7, 725	Swede Corners.....	7, 630
McIntyre Springs..	7, 520	Round Hill.....	8, 666	Valley View Springs	8, 390
M e a d o w ranch		Russell Springs....	7, 640	Veteran S. H.....	7, 600
house.....	7, 570	Saguache.....	7, 710	Villa Grove.....	7, 951
Mirage P. O.....	7, 670	Sanford.....	7, 600	Wagon Creek Junc-	
Mirage station....	7, 607	Sangre de Cristo... 8, 390		tion.....	8, 261
Moffatt.....	7, 558	San Isabel P. O.... 7, 560		Wagon Wheel Gap.	8, 439
Monte Vista.....	7, 655	San Luis Lakes.... 7, 520		Warner (or Forbes)	
Mortimer.....	8, 094	Santa Fe branch		S. H.....	7, 590
Mosca.....	7, 551	(at state line).... 8, 029		Washington Springs	7, 534
Orient mine.....	8, 750	Soldiers' Home.... 7, 630		Willis.....	7, 576
Orient station....	8, 659	South Farm ranch		Zapato.....	7, 715
Parma.....	7, 606	house.....	7, 630		

**DRAINAGE.**

The Rio Grande enters from the middle of the west side, pursues a southeasterly course to the San Luis Hills, and leaves through a defile in them. A number of tributary streams, notably Conejos River and La Jara, Alamosa, and Saguache creeks, flow down from the Conejos and Sawatch ranges, whose more gentle slopes give room for extensive drainage areas. Arms of the valley extend for some distance up the courses of the Conejos, the Rio Grande, and the Saguache, while a long, narrow arm, extending northward to Poncha Pass, the upper end being known as Homan's Park, is drained by San Luis Creek. The surface configuration of the valley is such that this creek should receive all the water entering the valley on either side, north of the Rio Grande, but as a matter of fact most of the drainage, especially that of the eastern range, is lost by seepage before it reaches the creek, or reaches it only in flood season. The creek itself in its lower course develops a series of wet-weather ponds and finally flows into the San Luis Lakes. The old overflow drainage course to the Rio Grande still exists but has been so blocked and concealed by incipient sand dunes as to be very difficult to trace except in its general features.

**HYDROGRAPHY.****STREAM GAGINGS.**

A gaging station has been maintained for many years at Del Norte, where the Rio Grande enters the San Luis Valley, and above the head-gate of the uppermost of the valley irrigation systems. Another one was maintained for a long period at Embudo, N. Mex., at the lower end of Embudo Canyon, into which the river flows just before crossing the Colorado-New Mexico line. From 1899 until 1904 a sta-

tion was also maintained at State Bridge, at the upper end of Embudo Canyon. This station, situated but a few miles below the cultivated area of the valley, was of great importance in determining the volume of water left in the river after the valley irrigation, and the discontinuance of this and the Embudo station is much to be regretted. Tables showing the monthly discharge at these stations and of Conejos River at Los Mogotes are subjoined.

*Discharge of Rio Grande at Del Norte, 1889-1905.*

[Drainage area, 1,400 square miles.]

Month.	1889.	1890.	1891.	1892.	1893.	1894.	1895.	1896.	1897.	1898.
	<i>Sec.-ft.</i>	<i>Sec.-ft.</i>	<i>Sec.-ft.</i>	<i>Sec.-ft.</i>	<i>Sec.-ft.</i>	<i>Sec.-ft.</i>	<i>Sec.-ft.</i>	<i>Sec.-ft.</i>	<i>Sec.-ft.</i>	<i>Sec.-ft.</i>
January.....	<i>a</i> 552	<i>a</i> 990	<i>b</i> 300	<i>a</i> 966	<i>a</i> 1,003	<i>a</i> 801	<i>a</i> 1,293	<i>ab</i> 1,000	<i>a, b</i> 1,377	
February.....	<i>a</i> 796	<i>a</i> 1,294	<i>b</i> 300	<i>a, b</i> 700	<i>a</i> 995	<i>a</i> 953	<i>a</i> 1,258	<i>ab</i> 1,000	<i>a, b</i> 1,472	
March.....	487	1,280	316	<i>a, b</i> 500	<i>a</i> 831	638	1,081	<i>ab</i> 1,000	<i>a, b</i> 1,471	
April.....	913	<i>a</i> 1,410	1,047	533	699	<i>a</i> 1,883	1,484	1,067	<i>a</i> 1,912	
May.....	4,331	3,285	2,605	1,944	1,798	2,116	2,374	3,537	2,722	
June.....	3,807	4,146	2,187	1,749	1,749	802	2,209	821	3,391	4,390
July.....	1,515	1,693	740	395	292	958	403	1,108	1,643	
August.....	612	663	444	324	309	720	261	475	509	
September.....	383	527	263	270	286	454	477	631	319	
October.....	<i>b</i> 278	470	844	259	263	289	435	469	1,472	259
November.....	319	478	374	360	278	236	353	310	665	<i>a</i> 816
December.....	281	<i>a</i> 565	<i>b</i> 325	<i>a</i> 922	<i>a</i> 642	288	<i>a</i> 1,008	375	<i>ab</i> 800	<i>a, b</i> 1,300
Mean.....	292	<i>a</i> 1,242	1,403	812	<i>a</i> 714	<i>a</i> 652	<i>a</i> 1,044	<i>a</i> 884	1,346	<i>a</i> 1,517
Acre-feet, total.....		900,926	1,014,426	590,219	516,886	471,408	754,931	641,017	945,418	1,094,950

Month.	1899.	1900.	1901.	1902.	1903.	1904.	1905.	Mean.	Equivalent in acre-feet.	Mean run-off. <sup>c</sup>	
										Second-foot per square mile.	Depth in inches.
	<i>Sec.-ft.</i>	<i>Sec.-ft.</i>	<i>Sec.-ft.</i>	<i>Sec.-ft.</i>	<i>Sec.-ft.</i>	<i>Sec.-ft.</i>	<i>Sec.-ft.</i>	<i>Sec.-ft.</i>			
January.....	<i>a</i> 1,308	<i>a</i> 862	800	381	895	895	895	895	55,031	0.639	0.737
February.....	<i>a</i> 1,113	<i>a</i> 1,005	900	412	938	938	938	938	52,094	.670	.698
March.....	<i>a</i> 875	399	500	438	755	755	755	755	46,423	.539	.621
April.....	617	419	710	638	748	652	760	968	57,600	.691	.771
May.....	1,378	2,854	2,570	1,169	2,829	1,158	3,411	2,505	154,026	1.79	2.06
June.....	1,091	2,691	1,782	618	5,189	716	6,090	2,605	155,008	1.86	2.08
July.....	703	547	594	152	1,655	336	1,091	864	53,125	.617	.711
August.....	598	231	464	180	526	689	578	474	29,145	.339	.391
September.....	365	256	446	206	515	692	376	404	24,040	.289	.322
October.....	492	343	262	242	349	1,449	430	506	31,113	.361	.416
November.....	490	253	283	249	390	390	390	390	23,206	.279	.311
December.....	<i>a</i> 742	<i>a</i> 755	366	547	494	494	494	494	30,375	.353	.407
Mean.....	814	<i>a</i> 884	806	436	1,274	764	1,351	.....	.....	.702	9.525
Acre-feet, total.....	589,293	641,017	583,271	315,790	920,561	553,019	957,738	.....	711,186	.....	.....

<sup>a</sup> Probably too high because of ice piling up along the sides of the stream and thus narrowing the channel. It is not likely that the winter flow is ever more than 600 second-feet. The totals are carried out, however, as though the observations gave a correct idea of the discharge.

<sup>b</sup> Approximate.

<sup>c</sup> The run-off given is for average months and the totals for an average year as calculated from all observations and estimates.

## Discharge of Rio Grande at State Bridge, 1899-1905.

[Drainage area, 7,695 square miles.]

Month.	1899.	1900.	1901.	1902.	1903.	1904.	1905.	Mean.	Equivalent in acre-feet.	Mean run-off.	
										Sec.-ft. per square mile.	Depth in inches
January.....	Sec.-ft. 638	Sec.-ft. 594	Sec.-ft. 521	Sec.-ft. 25	Sec.-ft. 306	Sec.-ft. 970	Sec.-ft. 509	31,297	0.066	0.076	
February.....	759	581	758	25	417	1,195	622	34,544	.081	.084	
March.....	583	365	549	34	123	870	421	25,886	.055	.063	
April.....	350	278	315	314	153	744	359	21,362	.047	.052	
May.....	1,430	1,680	490	2,012	21.5	6,494	2,021	124,266	.263	.303	
June.....	1,424	1,032	114	6,375	20.3	8,531	2,916	173,514	.379	.423	
July.....	42	29	82	22	1,178	17.5	233	14,327	.030	.035	
August.....	53	22	60	17	47	140	154	4,329	.0091	.010	
September.....	102	31	50	26	90	196	62.6	79.7	4,743	.011	
October.....	117	37	54	32	64	1,590	98.3	284	17,462	.037	
November.....	259	155	72	30	213	416	216	194	11,544	.025	
December.....	318	571	337	37	302	867	516	421	25,886	.055	
Mean.....	148	502	432	243	890	356	1,676	a 678	.071	1.19	
Acre-feet, total.....	54,069	362,304	312,513	173,518	642,607	259,200	1,210,000	489,160			

a The mean obtained is the mean of the monthly means for the entire period.

## Discharge of Rio Grande at Embudo, N. Méx., 1889-1893 and 1895-1903.

[Drainage area, 10,090 square miles.]

Month.	1889.	1890.	1891.	1892.	1893.	1895.	1896.	1897.
January.....	Sec.-ft. 431	Sec.-ft. 437	Sec.-ft. 586	Sec.-ft. 497	Sec.-ft. 332	Sec.-ft. 475	Sec.-ft. 532	Sec.-ft. 394
February.....	473	553	616	596	415	503	551	408
March.....	784	682	917	1,051	501	759	957	561
April.....	2,261	2,083	2,370	2,979	1,436	2,541	1,797	1,698
May.....	3,430	4,960	5,965	4,890	3,119	2,679	1,598	5,443
June.....	2,922	4,107	5,040	3,146	2,533	3,021	367	4,621
July.....	471	1,593	2,356	538	226	1,335	299	1,274
August.....	206	814	933	191	230	1,080	249	338
September.....	212	545	469	152	287	636	228	344
October.....	283	562	1,081	102	363	494	349	1,538
November.....	366	616	778	317	330	611	395	1,138
December.....	542	648	553	324	320	534	414	551
Mean.....	1,032	1,467	1,855	1,240	841	1,222	645	1,497
Acre-feet, total.....	747,070	1,064,377	1,348,217	899,730	608,996	885,279	467,960	1,107,818

Month.	1898.	1899.	1900.	1901.	1902.	1903.	Mean.	Equivalent in acre-feet.
January.....	Sec.-ft. 488	Sec.-ft. 470	Sec.-ft. 508	Sec.-ft. 341	Sec.-ft. 430	Sec.-ft. 317	Sec.-ft. 446	27,423
February.....	471	481	521	466	462	375	492	27,324
March.....	695	761	581	518	532	788	720	44,271
April.....	2,240	1,090	513	628	661	987	1,663	98,955
May.....	2,149	956	2,323	3,461	798	2,574	3,168	194,793
June.....	3,480	249	2,814	1,714	440	8,974	3,102	184,582
July.....	2,566	297	2,89	398	158	1,506	950	58,413
August.....	478	236	179	451	246	334	426	26,194
September.....	378	309	250	359	228	348	336	19,993
October.....	283	356	248	331	231	323	517	31,789
November.....	357	535	327	359	231	434	485	28,860
December.....	339	478	363	423	264	283	431	26,501
Mean.....	1,157	518	743	787	390	1,437	1,061	
Acre-feet, total.....	838,166	375,138	537,381	572,153	282,032	1,036,600		769,098

*Discharge of Conejos River near Los Mogotes, 1899-1905.*

[Drainage area, 282 square miles.]

Month.	1899.	1900.	1901.	1902.	1903.	1904.	1905.
	<i>Sec.-ft.</i>	<i>Sec.-ft.</i>	<i>Sec.-ft.</i>	<i>Sec.-ft.</i>	<i>Sec.-ft.</i>	<i>Sec.-ft.</i>	<i>Sec.-ft.</i>
March.....		<i>a</i> 144			<i>b</i> 436	283	297
April.....					1,291	509	1,544
May.....		<i>c</i> 1,087			2,323	320	2,226
June.....		<i>d</i> 467			645	76	528
July.....					173	316	213
August.....	<i>e</i> 76	<i>f</i> 33			157	233	87.4
September.....					138	515	71.5
October.....							
November.....	<i>g</i> 70						
Mean.....	73	433					
Acre feet, total.....							

*a* March 28.*b* April 17-30.*c* May 11.*d* June 23.*e* August 25.*f* August 17.*g* November 28.

## RELATION OF SAN LUIS VALLEY IRRIGATION TO THE VOLUME OF THE RIO GRANDE IN NEW MEXICO.

At this point it may not be amiss to call attention to some facts bearing on the interstate relations of irrigation in the San Luis Valley. Agriculture and irrigation spread up the Rio Grande valley from Mexico and Texas, through New Mexico to the San Luis Valley in Colorado. With the rapid expansion of irrigation in the San Luis Valley the water of the Rio Grande was largely withdrawn in Colorado, to the alleged great detriment of agriculture on the lower course of the river. The question of prior rights to the use of the water became a subject for interstate and international discussion. Major Powell in 1890, testifying before the Senate Special Committee on Irrigation and Reclamation of Arid Lands,<sup>a</sup> said:

Passing into New Mexico, then, the water that practically heads in the high mountains of Colorado is largely, almost wholly, cut off from the Rio Grande, so that no portion of the water that heads in these mountains where there is great precipitation will cross the line into New Mexico (in the dry season) \* \* \*. In a dry season nothing can be raised in the lower region and sometimes dry seasons come two or three together.

Nevertheless, Major Powell argued that it is advantageous that the water in a stream be used for irrigation as near to its source as possible, since there the duty of water is greatest and the loss from evaporation and seepage is least.

In the valley of the Rio Grande the greater portion of the water during the season of irrigation is lost in the sands, as in the valley of the Arkansas. If the water of the Rio Grande is compelled to flow across the line from Colorado into New Mexico, it will destroy from 1,000,000 to 1,500,000 acres of agriculture above in order to save 200,000 or 300,000 acres in the valley below.

Major Powell urged that the tributaries of the Rio Grande below the Colorado-New Mexico line would, if the water were conserved, fur-

<sup>a</sup> Rept. Special Committee of the U. S. Senate on Irrigation and Reclamation of Arid Lands, vol. 4, pp. 17-33.

nish a sufficient flow to maintain the irrigation of that section as then developed. He pointed out that "when the river emerges into the valley at the foot of Embudo Canyon it is a fine stream and *must always be so whatever water is taken out in Colorado above*" (italics mine). That this somewhat startling and paradoxical statement is borne out by the facts is indicated in the following paragraphs, where the explanation is suggested.

The table on page 20, giving the comparative acreage irrigated from the Rio Grande and its tributaries in 1889 and 1899 shows, an increase in that period of over 100 per cent, yet the discharge of the Rio Grande at Embudo (table, p. 14) shows no corresponding systematic diminution during the irrigation months, notwithstanding that the water is almost wholly removed from the river in its course through the valley, as shown by the gage at State Bridge. The following table of the comparative discharge at Del Norte, State Bridge, and Embudo for 1900 to 1903, inclusive, the period for which we have data from all three points, brings out the fact clearly:

*Comparative discharge, in second-feet, of the Rio Grande at Del Norte, State Bridge, and Embudo, 1900-1903.*

	1900.			1901.		
	Del Norte.	State Bridge.	Embudo.	Del Norte.	State Bridge.	Embudo.
January.....	862	638	508	800	594	341
February.....	1,005	759	521	900	581	466
March.....	399	583	551	500	365	518
April.....	419	350	513	710	278	628
May.....	2,854	1,430	2,323	2,570	1,680	3,461
June.....	2,961	1,424	2,514	1,782	1,032	1,714
July.....	547	29	289	594	82	398
August.....	231	22	179	464	60	451
September.....	256	31	250	446	50	359
October.....	343	31	248	262	54	331
November.....	253	155	327	283	72	359
December.....	755	571	363	366	337	423
Total acre-feet.....	641,017	362,304	537,381	583,271	312,518	572,153

	1902.			1903.		
	Del Norte.	State Bridge.	Embudo.	Del Norte.	State Bridge.	Embudo.
January.....	381	521	430	.....	25	317
February.....	412	758	462	.....	25	375
March.....	438	549	532	.....	34	788
April.....	638	315	661	748	314	927
May.....	1,169	490	790	2,829	2,012	2,574
June.....	618	114	440	5,189	6,375	8,974
July.....	152	22	158	1,655	1,178	1,506
August.....	180	17	246	526	47	334
September.....	206	26	228	515	90	348
October.....	242	32	231	349	64	323
November.....	249	30	231	.....	213	434
December.....	547	37	264	.....	302	283
Total acre-feet.....	315,790	173,518	282,032	920,561	642,607	1,036,600



Comparison of the measurements at Del Norte with those at Embudo for the whole period from 1890 to 1903, inclusive, shows further that the river as it is discharged from the canyon is very nearly of the size that it is at Del Norte. That is to say, during the season of low water there is added to the river, in the course of its passage through the canyon a volume nearly equal to that of the river at Del Norte. Examination of the topography of the country shows that no tributaries of any consequence come into the canyon from the west and from the east, but six small creeks flow into it, namely, Costillo, Colorado, San Cristobal, Los Montes, and Pueblo creeks and Arroyo Hondo. These are all short, with high gradients, and head in the range just east. Even in flood they carry no such volume of water as the Rio Grande at low stage; but the season alluded to was that of low water, and during such times all the water in these creeks is practically exhausted in irrigating the bottoms adjacent to them. The increment to the river in the Embudo Canyon must be explained in some other way. A. L. Fellows, formerly United States hydrographer in charge of work in Colorado and New Mexico, has noted the occurrence of large springs in the canyon above Embudo station and has suggested that the San Luis artesian basin finds an outlet in this way. No description of these springs is extant, and their location, size, and number are unknown. The strata which go to make up the Conejos Mountains and the San Luis Hills form an alternating series of gravel beds and lava flows, as will be shown more in detail on a later page. At the south rim of the valley, where the water-bearing beds of the valley abut against the San Luis Hills, a great many springs come up along the contact, among them the McIntire Springs (Pl. XIII, *B*) with a flow of over 20 cubic feet per second. It is reasonable to suppose that other water-bearing beds in contact with the interstratified gravel beds of the older formation will communicate their water to those gravel beds and that the Rio Grande itself may do likewise, and that this water may be poured into the canyon at different points above Embudo. The increment thus gained is apparently not less than 150 second-feet and possibly is considerably more, the exact amount being difficult to determine owing to irregularities in the record. For instance, in the winter months the record occasionally shows more water at State Bridge than at Embudo, which naturally seems impossible, there being no known source of loss between the two stations. The error probably arises from encroaching shore ice, which causes too high gage readings at State Bridge, where the channel is narrow.

Experiments have shown that the movement of water underground in sand and gravel beds is very slow, usually 1 or 2 miles per annum, certainly not over 3 in the extreme case. This being so, it follows

that the supply from springs in the canyon, if derived from the aquifers in the San Luis basin, is practically constant, since the amount delivered in any period of time is not dependent upon the rainfall during the same period, because the water rising in the springs has been percolating slowly underground for many years before it reaches the surface. Further, the principal intake of the artesian system on the Rio Grande is well toward the edge of the valley, between Del Norte and Monte Vista, above the head-gates of all but one of the main canals, and as this canal has a later priority than one below the catchment area, it follows that the artesian basin has the first call upon the flow of the Rio Grande and of the other streams as well. That this supply is exacted is shown by the fact that there is no annual variation in the head of the wells which just reach the surface along the margin of the area of flowing wells. These facts bear out Powell in the statement quoted at the beginning of this discussion that the flow of the Rio Grande below the Embudo Canyon will always be largely independent of the flow at the head of the canyon. Thus the sands and gravels of the San Luis Valley act as a natural reservoir with lasting benefit to the Rio Grande valley below.

#### RESERVOIR SITES.

The great excess of water wasted during the flood season and the frequent lack of water when needed have turned attention to the possibility of reservoirs in the upper courses of the streams to conserve the flood water and have led to search for available sites. Naturally those first sought are the ones requiring the least expenditure of money to make them available. The head branches of most of the larger streams emptying into the valley held glaciers of various size during past ages, and many of the morainic dams and terraces resulting from glacial action offer tempting sites for storage reservoirs. Such formations require most careful testing, because from the nature of their material they will not, as a general rule, hold water after it has accumulated in volume sufficient to cause much pressure. But doubtless there are numerous sites in the various streams that will serve admirably. Such are reported on Alamosa Creek and in the upper course of the Rio Grande. One of those on the Rio Grande has been thoroughly tested by the company operating the Rio Grande and Monte Vista canals, and a reservoir is now under construction.

The high gradient and the small drainage areas of the streams coming down from the Sangre de Cristo Range preclude the establishment there of any but small irrigation systems. On the other hand, the low gradient and larger drainage areas of the streams entering from the west side of the valley are very advantageous to large systems. Toward their headwaters these streams branch out and their

valleys take on the rolling character of glaciated cirques and are heavily covered with pine and spruce, as shown in the typical view of upper Rock Creek (Pl. II, B). The timber, by checking the runoff in time of heavy rains and by protecting the snow from rapid melting, controls the discharge of the streams and to that extent does away with the necessity for storage reservoirs.

In accordance with a recommendation of the United States and Mexican International Boundary Commission in 1896, the Secretary of State requested the Secretary of the Interior to withdraw from entry all reservoir sites in the Rio Grande drainage area and to suspend action on all applications for rights of way for canals through public lands. Such action was accordingly taken December 5, 1896. Recently, upon the suggestion of the United States Reclamation Service, this order has been suspended in so far as it relates to bona fide applications made under the state law prior to March, 1903, when the Reclamation Service took up the Rio Grande project. From that date, of course, the project has the priority. The proposed reservoir at Engle, N. Mex., will have a storage capacity of 2,000,000 acre-feet, irrigating 180,000 acres, and will be capable of storing all the flood waters of the Rio Grande from year to year.

## IRRIGATION.

*Canals.*—The full flows of all the streams entering the valley are appropriated for purposes of irrigation. The Rio Grande is the main source of supply. The following table shows the total appropriations and dates of the main priorities of the principal canals and ditches taking water from that stream, as decreed by the courts in 1900:

*Water appropriated for principal ditches and canals from the Rio Grande, and total decreed appropriation.*

Priority.	Canal.	Appropriation.
		<i>Cubic feet.</i>
1874 and 1879.....	Centennial ditch.....	82.4
1881 and 1891.....	Rio Grande (Del Norte) canal.....	905.6
1882 and 1889.....	Monte Vista (Citizens') canal.....	257.8
1882 and 1890.....	Empire canal.....	667.5
1885.....	San Luis Valley canal.....	92.9
1886.....	Costilla ditch.....	103.3
1887.....	Prairie ditch.....	105.1
1887.....	Farmers' Union canal.....	138.8
	Total for principal ditches and canals.....	2,353.4
	Total appropriation decreed by court to 1900.....	3,022.59

The foregoing table, when compared with the table giving the average monthly flow of the Rio Grande from April to September, inclusive, for sixteen years (p. 20), shows that the waters of this stream are greatly overappropriated, even in the flood season.

*Average monthly discharge of the Rio Grande at Del Norte, 1890-1905.*

	Second-feet.
April.....	968
May.....	2, 505
June.....	2, 605
July.....	864
August.....	474
September.....	404

*Acres irrigated from the Rio Grande and tributaries. a*

County.	1899.	1889.	Per cent increase.
Hinsdale.....	1, 339	1, 389	.....
Mineral.....	.....	2, 640	.....
Saguache.....	75, 909	52, 453	44. 7
Río Grande.....	71, 325	21, 797	227. 2
Costilla.....	50, 290	25, 918	94. 0
Conejos.....	98, 486	46, 273	112. 8
	299, 989	147, 830	102. 9

<sup>a</sup> Census Bulletin 177, 1902, p. 14.

This acreage is confined to the San Luis Valley, except perhaps 10,000 acres lying on the upper courses of the river or its tributaries.

The total area of the irrigated land in same region for 1902 is given by the Bureau of the Census<sup>a</sup> as 303,985 acres. This shows no material increase over 1899. Later figures are not available.

*Pumping the "sub."*—Between Mosca and Hooper is a region in which the supply of ditch water for several years has been inadequate, and here was developed the scheme of installing a gasoline pumping plant and pumping from the underground water level as raised and maintained by subirrigation. No change in the application of the water thus gained was proposed. It was to be used in subirrigating; that is, the level of underground water was to be raised by adding to it water taken from it—another statement of the problem of raising one's self by one's boot straps. The application of the water might be changed by the substitution of surface irrigation for subirrigation methods, thus doing away with the necessity of keeping up the underground water level; but a difficulty appears in that case. The interesting question is raised as to the right of one person to lower the water level when his neighbors, in the customary practice of irrigation, are under the necessity of keeping it up.

*Pumping the underflow.*—Many of the smaller streams on either side of the valley run out into the valley during the flood season but during the remainder of the year, except for short intervals, disappear beneath the gravel, where they emerge from the mountains at the upper edge of the alluvial slope. But by digging down a few feet in

<sup>a</sup> Bulletin 16, Irrigation in the United States: 1902, p. 55.

the rocky channels of such streams a persistent and heavy underflow is encountered. It is possible by installing a gasoline pumping outfit to raise this underflow and irrigate successfully when the water is not running in the streams. One such pumping outfit has been in successful operation in 1903 and 1904 by Mr. K. Eilinghoff 2 miles east of Chamberlain Hot Springs. The equipment consisted of a  $3\frac{1}{2}$ -horsepower gasoline engine and a 2-inch centrifugal pump with a normal discharge of 125 gallons per minute. The water was taken from a well 16 feet deep, in which the water stood within 7 feet of the surface but with steady pumping sank to 11 feet from the surface, where it remained.

The cost of installing such an outfit is not large, and the cost of operation for the short time it would ordinarily be in use, at critical periods in the growth of the crop, will also be small, so that there seems to be a genuine need for such plants, particularly in the northern portion of

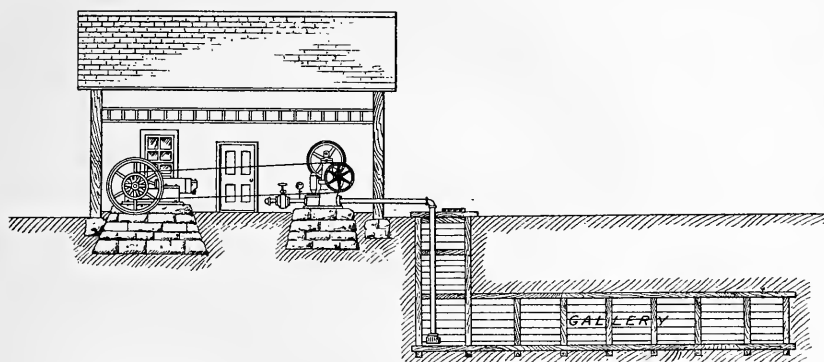

FIGURE 2.—Plan of pumping plant, showing subterranean gallery.

the valley and wherever else the supply of ditch water is short and the underflow sufficient.

Where the underflow may not be adequate with a simple well, a subterranean gallery will be found more efficacious. The accompanying plan (fig. 2) of the city pumping plant of Castle Rock, Colo., may be advantageously copied in designing outfits of this sort.

*Canvas flumes.*—Along the west slope of the Sangre de Cristo Range many streams afford water that is sufficient to irrigate small tracts but in the irrigation season is entirely lost in passing over the alluvial slope at the foot of the range. A plan adopted by the placer miners of Alaska, and used in irrigation in California, might possibly be worked here to advantage. At some places in Alaska water is carried on the surface of the ground for miles in a flume made by sewing together the two sides of a strip of cotton duck canvas, making a long canvas pipe. Or the bottom of a ditch may be lined with such canvas.

The cloth will be less subject to damage by cattle and rodents, however, when sewed up in the form of a hollow cylinder and filled with water. Such a flume might conceivably last for several irrigation seasons of a couple of months each. A subsurface dam across the canyon near its discharge upon the alluvial slope would help by bringing all the underflow of the stream to the surface at the intake of the flume.

#### CLIMATE.

The most prominent feature of the climate of the San Luis Valley is the prevalence of sunshine. Records are not at hand to show this fact with exactness, but, except for short intervals each day during the brief summer showery season and other rare occasions, sunshine prevails throughout the year. Taken in conjunction with the dry, rarefied atmosphere at this altitude, which allows a large amount of the sun's heat to reach the earth's surface and permits rapid radiation therefrom, this sunniness acts to relieve the worst extremes of day-time temperature. On the hottest days it is cool in the shade, and on the very coldest days it is comfortable in the sunshine.

The most disagreeable feature of the climate is the southwest wind, which occasionally blows steadily for several days at a time, picking up the sand and driving it onward with the force of a sand blast.

The following tables of temperature and precipitation are based upon observations at each of the towns named for the period indicated. The value of such observations is strictly in proportion to the interval of time that they cover. The records which are thus of greatest value are those taken at San Luis, Saguache, Garnett, and especially the temperature records at Fort Garland, though those from Monte Vista and Wagon Wheel Gap are also complete enough to be of interest. The data included in these tables were furnished by the United States Weather Bureau, and, except the Fort Garland observations, through Mr. F. H. Brandenburg, district forecaster at Denver, Colo. The temperatures in the tables, as elsewhere in this report, are expressed in degrees Fahrenheit.

The observations at Fort Garland, covering a period of thirty years, with a short interruption in 1864-1866 and entirely antedating the other observations in the valley, are of especial interest because of their length and the opportunity they afford for comparison. For the period 1852-1858, inclusive, the observations were made at Fort Massachusetts, in the valley of Ute Creek, a short distance above the present site of Fort Garland, where the military post was removed in 1858.

*Average monthly temperature at stations in San Luis Valley.*

[Degrees Fahrenheit.]

	Jan.	Feb.	Mar.	Apr.	May.	June.	July.	Aug.	Sept.	Oct.	Nov.	Dec.	Term of record.
Saguache.....	18.3	23.6	33.6	43.4	51.6	63.8	64.4	62.7	55.7	45.4	33.0	20.	1886-1905
Garnett.....	13.5	21.7	31.2	41.6	49.2	57.8	61.3	60.6	53.6	41.4	30.0	13.4	1897-1905
Monte Vista.....	16.1	20.8	32.3	41.6	51.8	59.1	63.5	62.5	55.2	43.8	29.7	17.9	1886-1896
La Jara.....	22.1	22.3	34.8	45.0	52.3	60.8	64.2	63.7	58.5	47.6	35.2	25.0	1892-1897
Conejos.....	18.1	26.2	35.5	41.8	49.4	58.0	62.5	62.6	58.8	45.3	36.2	18.6	1904-1905
San Luis.....	19.5	24.2	33.3	42.3	50.5	58.6	63.1	62.4	55.8	45.3	34.0	22.5	1891-1905
Fort Garland.....	18.2	22.8	33.5	41.3	52.0	62.0	66.2	63.7	55.2	44.1	30.0	21.2	1852-1883
Average...	18.0	22.9	33.2	42.1	51.3	60.8	64.3	62.8	55.5	44.6	31.6	20.	
Wagon Wheel Gap.....	12.9	17.6	26.8	35.4	42.2	50.4	54.5	54.7	47.9	38.3	27.1	12.7	1898-1905

The extremes of temperature for summer and winter at Saguache, Garnett, and San Luis are included in the next table. The lowest figure recorded is 40° below zero at Garnett in December and the highest figure is 98° at San Luis in August. The observations at Garnett are the most typical of the valley, as the station lies in the full sweep of the valley winds, while Saguache and San Luis are protected by the adjacent foothills. The monthly mean temperatures for the winter months at Garnett range from 1° to 10° lower than at Saguache and San Luis, and the range of the extremes is still greater.

*Maximum and minimum temperatures at Saguache, Garnett, and San Luis.*

[Degrees Fahrenheit.]

Month.	Average.	Highest.	Lowest.
Saguache:			
December.....	21	63	-26
January.....	18	59	-23
February.....	23	64	-13
June.....	60	92	28
July.....	65	97	31
August.....	63	94	35
Garnett:			
December.....	13	55	-40
January.....	13	52	-30
February.....	22	64	-33
June.....	58	89	20
July.....	61	88	29
August.....	61	92	30
San Luis:			
December.....	22	58	-30
January.....	20	57	-30
February.....	24	63	-34
June.....	59	96	23
July.....	64	95	30
August.....	63	98	32

The next table gives the average monthly precipitation at various points in the valley calculated from all available records. The figures for the precipitation at Fort Garland and Wagon Wheel Gap are added for the sake of comparison, though they have been excluded in making up the average for the valley, the former for reasons given later and the latter because the station is not within the valley proper. From the valley average it will be seen that July has the greatest precipitation, with occasional showers in August and September.

## Average monthly precipitation at stations in San Luis Valley.

[Inches.]

	Jan.	Feb.	Mar.	Apr.	May.	June.	July.	Aug.	Sept.	Oct.	Nov.	Dec.	Term of record.
Saguache.....	0.26	0.35	0.21	0.62	0.89	1.10	1.80	1.80	0.86	0.70	0.28	0.23	1886-1905
Garnett.....	.08	.24	.23	.25	.72	.59	1.23	1.35	.84	.40	.25	.25	1891-1905
Monte Vista.....	.24	.51	.32	.85	.81	.29	1.58	1.28	.87	.48	.22	.32	1886-1896
La Jara.....	.11	.91	.13	.15	1.00	.22	1.13	1.04	.64	.69	.30	.03	1892-1896
Conejos.....	.78	.67	.20	.00	.06	1.00	.94	1.46	3.53	.99	.00	.47	1904-1905
San Luis.....	.49	.64	.89	.95	1.23	.67	2.26	1.27	1.18	.92	.36	.79	1891-1905
Average for valley.....	.29	.48	.42	.62	.91	.65	1.66	1.19	.97	.66	.28	.40	
Fort Garland.....	.18	.82	.40	.72	.90	.72	1.93	1.78	1.31	.54	1.10	.87	1852-1874
Wagon Wheel Gap.....	.45	.64	.90	.99	1.03	.59	1.53	2.19	1.42	1.09	.68	.41	1898-1905

The next table gives the yearly precipitation for each point in the valley and the average for the valley itself for 1887-1905, inclusive, so far as there are records, except for Fort Garland. The record of Wagon Wheel Gap is added, as of interest from its position in the upper drainage basin of the Rio Grande. The mean annual precipitation for the valley is 8.33 inches. The maximum annual precipitation is 18.85 inches, recorded at San Luis in 1891, and the minimum is 2.88 inches, given for Saguache in 1896. San Luis and Wagon Wheel Gap have the highest average annual precipitation, as is to be expected from their geographic position. The precipitation on the mountains about the valley, and especially high up in the Sangre de Cristo and Culebra ranges east of the valley, is doubtless much greater than in the valley, owing to the fact that the southwest moisture-laden winds are forced to ascend to colder altitudes in crossing over those ranges, with local precipitation as a result.

## Average annual precipitation at stations in San Luis Valley.

[Inches.]

	1887.	1888.	1889.	1890.	1891.	1892.	1893.	1894.	1895.	1896.
Saguache.....	10.69	4.41	7.05						14.01	2.88
Garnett.....						4.87	4.46	6.33	10.37	3.50
Monte Vista.....	8.48	6.21	5.01	6.48	9.17	7.47	6.84	6.22	9.12	
La Jara.....							7.15	6.75	9.44	
Conejos.....					18.85	11.04	10.87	10.58	15.76	12.31
San Luis.....										
Average for valley.....	9.59	5.31	6.03	6.48	14.01	7.79	7.33	7.47	11.74	6.23

	1897.	1898.	1899.	1900.	1901.	1902.	1903.	1904.	1905.	Average.
Saguache.....	8.84	8.06	5.96	6.25	6.86	7.09	6.51	7.26	3.76	7.12
Garnett.....	6.25	4.60	6.96			8.18	5.18	9.51	7.08	6.44
Monte Vista.....										7.22
La Jara.....										7.78
Conejos.....								9.86		9.86
San Luis.....	13.93	14.20	10.04	10.16	13.02	7.45	6.98	9.56	10.14	12.71
Average for valley.....	9.67	8.95	7.65	8.21	9.94	7.57	6.22	9.05	7.00	8.22
Wagon Wheel Gap.....		12.26	12.25	7.83	9.73	10.28		14.50		12.81



As explained with regard to the table of average monthly temperatures, the table of precipitation that follows combines the observations at Fort Massachusetts and Fort Garland. The figures for 1870-1872, inclusive, are regarded by the United States Weather Bureau as very questionable, and they have accordingly been excluded in making the averages. Aside from these years the table appears to be fairly reliable, and is of much interest for purposes of comparison.

*Precipitation at Fort Garland, 1852-1863 and 1866-1874.*

[Inches. Blanks indicate incomplete records.]

Year.	Jan.	Feb.	Mar.	Apr.	May.	June.	July.	Aug.	Sept.	Oct.	Nov.	Dec.	Annual.
1852.....										1.84	6.34	1.45	9.63
1853.....	0.22	0.76	0.94	0.39	1.49	1.11	3.04	1.48	1.25				10.68
1854.....					3.93	.24	2.14	2.61	1.53	.35		2.30	13.10
1855.....	.00	.67	1.47	.41	.98	.86	2.60		3.33	.00	5.27	.38	15.97
1856.....	.15	2.14	.35	1.35	.00	.55	2.19	3.30	1.55	.95	.79	.55	13.87
1857.....	.80	.52	.20	1.51	.75	.95	.72	3.98	1.34	1.19	2.03	.67	14.66
1858.....	.54	.20	.08	2.11	1.00	.58	1.36			1.22	.68	.15	7.92
1859.....	.00	.15	.27	.19	.32	1.32	2.72	4.75	.68	.55	.20	.20	11.35
1860.....	.20	.08	.53	.33	.00	.72	2.61	.77	.85	.25	.24	.04	6.62
1861.....	.03	.04	.87	.25	1.01	1.07	.74	.30	.93	.13	.06	.01	5.44
1862.....	.24	.02	.16	.40	.24	.41	1.26	1.46	1.78	.00	.22	.14	6.33
1863.....		.84	.06	.00	.22	1.07	.07	.02	.03	.13	.21	.24	2.89
1866.....									.79	.35	.08	.13	1.35
1867.....	.06	.15	.12	.89	.21	.01	.36	.29	.26	.02			2.37
1868.....	.16		.12			.01	7.19	3.26	1.80	.42	.03	4.01	17.00
1869.....	.65	.90	.28	.36	2.30	.77	1.28	1.03	2.55	.16	.14	3.00	13.42
1870 <sup>a</sup> .....	.65	1.05				6.65	7.30	7.50	9.00	1.30	.15	3.35	37.87
1871 <sup>a</sup> .....	1.20	1.45	2.80	2.45	1.45	.25	1.00	1.25	2.90	1.40	7.10	1.75	25.00
1872 <sup>a</sup> .....	2.25	2.75	3.65	2.78	6.25	7.75	10.30	5.08	.83	.10	.00	.00	42.34
1873.....	.00	2.25	.00	1.75	.00	1.58	.80	.48	.18	.50	.01	.20	7.75
1874.....	.50	2.80	.50	.15	.08	.20	1.72	1.12	2.05	1.23	.25	.50	11.10
Average.....	.18	.82	.40	.72	.90	.72	1.93	1.78	1.31	.54	1.10	.87	<sup>b</sup> 11.27

<sup>a</sup> Record unreliable.

<sup>b</sup> Average annual precipitation excluding 1870-1872, inclusive.

## AGRICULTURE.

### ORDER OF SETTLEMENT.

The first population of the San Luis Valley was Mexican, and the little Mexican "plazas" are scattered along both sides of the valley but are more numerous in its southern part. The Mexicans constructed no large-irrigation ditches, and their settlements were perforce limited to the mountain valleys, to the border of the San Luis Valley, and to the immediate banks of the perennial streams in the valley.

Following the advent of Americans came colonization schemes and the construction of larger canals, permitting the central part of the valley to be settled. North of the Rio Grande the country adjacent to the railway, irrigated by the Farmers' Union, Prairie Ditch, and San Luis canals, was first settled in preference to the more gravelly soil to the west. Gradually, however, the gravelly land was found to be fertile and suited to cultivation as well as the other, and the cultivated territory spread farther westward. Then, from a combination of causes, the land that lay to the east along the railway and was the first to be cultivated was practically abandoned. These causes were

(1) exhaustion of the soil by continuous cropping without rotation; (2) exhaustion of the water in the canals by farms nearer the heads of the canals; (3) failure of the canals in years of drought through lateness of their priorities; (4) injurious accumulation of alkali in the soil. This accumulation of alkali is due to the prevailing practice of subirrigation. The alkali is largely of local origin, a result of the concentration at the surface of the salts in the soil of the affected region itself, but is also partly derived from the soil of the contiguous and higher regions to the west and carried by seepage water to the lower land, there coming to the surface and being precipitated.

Remnants of the population brought in by colonization schemes exist in different parts of the valley, as, for instance, settlements of French Canadians about Carnero, of Scandinavians at Swede Corners south of Saguache and in the neighborhood of Swede Schoolhouse southwest of Alamosa, and of Mormons at Manassa, Sanford, Richfield, Freedom, and, until recently, at Zapato.

#### NATIVE VEGETATION.

The native vegetation of the valley varies with the region and the ecologic conditions. On the high mountain sides pine, aspen, and spruce, lower down piñon and cedar, and in the valleys and along streams cottonwood and willow constitute the forest growth. The valley bottom away from streams is covered with a growth of "chico" and "greasewood," the former predominating in adobe soils and both growing in the loams. Sagebrush does not grow in the valley bottom but is found in the foothills in places. Wild currants and raspberries thrive abundantly, growing well up the mountain slopes. Of the currants three varieties are found, black, red, and yellow.

Much native hay is grown along the bottoms of the streams that come down into the valley from either side. These vegas, or native meadows, were among the first tracts taken up as homesteads, and on account of their value and the ease of cropping are not plowed up to be planted in other crops unless they run out. The market for hay is largely local, yet some is shipped.

#### CULTIVATED CROPS.

The principal crops are wheat, oats, wild hay, alfalfa, potatoes, peas, and barley. Wheat was the first crop and is the most important crop to-day. Very little trouble was taken in planting wheat by the early settlers. The brush was uprooted by dragging a heavy railroad rail across the land, raked up into windrows and burned, and the wheat drilled in directly without plowing. Such methods sufficed to get large yields and led to the planting of large acreage and the building of mills and elevators at Del Norte, Monte Vista, Hooper,

Mosca, Alamoña, La Jara, and Conejos. In time the heavy wheat returns failed and crops were rotated, or the fields were planted in alternate years, lying fallow in the intervals.

In the last few years, however, a new industry has sprung up, which yields good returns and which, in the long run, will be more valuable, in that it will restore the land to its pristine fertility. This is the business of fattening young lambs for the spring markets. Quarter sections are grown with peas, or a mixture of peas and oats, and the lambs are pastured on these, thus at one stroke doing away with the need of harvesting the crop and hauling it to market, besides resting the land by raising a leguminaceous crop and returning nearly all the mineral plant food to the soil. The practice promises to spread rapidly and will unquestionably make for the good of the valley. The meat of lambs fed on peas is said to be much improved in flavor and at all times commands the best prices.

The late and short growing season in the valley of necessity cuts out some fruits and crops. Early corn will in a favorable year make small roasting ears. Apples and pears have been grown in protected places, but these are unimportant and fruit is mostly imported from the outside.

#### METHODS OF IRRIGATION.

In the San Luis Valley the method of irrigation practiced almost universally is a modification of subsurface irrigation, locally known as "subirrigation." In subsurface irrigation the water is carried in underground tile or perforated pipe directly beneath the roots of the plant to be irrigated, as, for instance, beneath a row of fruit trees. In subirrigation, as practiced in the valley, the water is conducted onto the field in trenches at such distances apart as experience and the character of the soil shall determine. These trenches are closed at the lower ends and water is supplied to them only so fast as it is taken up by the sides and bottom of the trenches, care being taken to prevent overflowing. The loamy character of the soil allows it to absorb the water rapidly, while the level character of the surface permits the raising of the level of ground water to a height within reach of the rootlets of the growing crops. The object in view is to keep the level of the underground water at this height. If the spring rains have not left the water level near the surface, it may be brought so by a preliminary flooding.

This method requires much less care and trouble than the method of flooding or surface irrigation, and is as efficacious as that method, though it requires much more water. Its long-continued practice, however, brings a result that is detrimental; that is to say, it renders the soil alkaline. In countries of greater rainfall, where irrigation is not needed, the constant flooding of the soil since its formation as a result

of heavy rains and the consequent run-off has leached from it much if not all of its content of injurious salts, as well as much of the mineral matter needed as plant food. For the same reason, in the so-called arid regions, correlated with the liability to become alkaline under careless irrigation is the greater fertility of the land due to the greater abundance of mineral plant food.

The salts which render soil alkaline are, in the order of their injurious effects, sodium carbonate ("black alkali"), sodium sulphate ("Glauber's salt"), and sodium chloride (common salt). These are originally so widely scattered in small particles through the soil and subsoil as not to be injurious. They are very readily dissolved in the water put on in subirrigation, which penetrates both the soil and the subsoil. As this water is drawn to the surface and evaporated, it leaves these salts behind it on the surface of the ground. As a result of this continuous process, the salts are leached from the soil and subsoil and accumulate on the surface of the soil, rendering it in time unfit for tilling. Once in solution, the only way the salts are redeposited in the soil is by evaporation. The remedy is of course to reverse the process of irrigation; that is to say, to apply the water at the surface, preferably by flooding, and to withdraw it from below by drainage, thus continually carrying away the salts in solution and lessening their amount in the soil. This method, as just pointed out, has the disadvantage of removing from the soil some of its valuable elements.

Not all of the water comes immediately to the surface to be evaporated, especially on the less gently sloping gravelly land of the alluvial-fan formations to the west. A portion of the water continues down the slope as underflowing ground water until forced to the surface by clay beds beneath. Here it issues as a "seep," usually making an "alkali spot."

The alkali map accompanying the report on the soil survey of the San Luis Valley,<sup>a</sup> to which the reader is referred for further details, shows that in the region surveyed the most alkaline territory lies in a semicircle about the foot of the steeper part of the great Rio Grande alluvial fan. The author of the report says that "the subformation is such that the ground water is naturally near the surface in this territory." In other words, this is the region where the superficial gravelly and sandy covering of the fan thins out and the clay beds of the Alamosa formation approach the surface.

How short-sighted was the man who congratulated himself because his land required no irrigation when his next neighbor's land above was thoroughly saturated or "subbed." He simply was slowly accumulating a large part of his neighbor's alkali. Perhaps his

---

<sup>a</sup> U. S. Dept. Agr., Field operations of the Bureau of Soils, 1903, pp. 1099-1119.

neighbor in turn was having alkali unloaded upon his land. But the man for whom there is no escaping the alkali under the system of subirrigation is the one on whose place the seep rises to the surface. As noted before, the remedy lies in surface application of the water, with subsurface drainage, not only greatly lessening the needful amount and making the supply irrigate a larger territory, but carrying away the alkali.

The report referred to above, based on careful study of the valley, concludes that the amount of alkali in the valley is nowhere so great as to preclude successful reclamation by proper methods.

## GEOLOGY.

### INTRODUCTORY STATEMENT.

Popularly the San Luis Valley or park is supposed to be the southernmost one of a chain of four great parks, of which North, Middle, and South parks are the others; in reality, it differs genetically and geologically from that series, which, with its southern continuation, Wet Mountain Valley and Huerfano Park, occupies a depression between the Front Range and Wet Mountain axis and the Mosquito Range and Sangre de Cristo axis, whereas the San Luis Valley occupies a depression west of the latter axis and between it and the Sawatch Mountains. Furthermore, the former depression began to take shape much earlier—as far back as the Triassic at least—and has been subject to sedimentation more or less continuously from that time until the Pleistocene, whereas the San Luis Valley shows no formations older than Miocene, and is for the most part occupied by Tertiary or early Quaternary sediments.

For purposes of geologic description the valley and its environment divides itself naturally into four parts—the west ranges, the east ranges, the San Luis Hills, and the valley proper.

### THE WEST RANGES.

The western mountains, the Sawatch and Conejos ranges, are made up, on their eastern flanks adjacent to the San Luis Valley, of alternations of gravel beds, andesitic flows, and rhyolitic tuffs cut through in places by dikes and the volcanic necks of centers of effusion. These flows incline toward the valley with dips varying from  $6^{\circ}$  to  $15^{\circ}$ , and extend under it, being penetrated in some of the wells at the south end of the valley. In Plate III, A, the lava-capped mesa that stretches eastward from Los Mogotes Peak and is cut through by the canyon of Conejos River is seen gradually to approach and merge with the floor of the valley.

## ALAMOSA CREEK VALLEY.

Alamosa Creek leaves the foothills about 6 miles west of Capulin, through a defile in the lava rim. The south side of the defile rises into a bluff a hundred feet high, which is shown in Plate III, *B*. This bluff, capped with pyroxenite-andesite<sup>a</sup> 40 feet in maximum thickness, dips 8° to 10° E. The lower part is massive and lies upon a water-sorted conglomerate, at the contact with which the lava is much broken. Boulders from the conglomerate seem to be drawn up into the lava, and it is penetrated by crevices and "chimneys" of loose-textured rock, apparently the result of steam escaping when the flow covered the conglomerate. The conglomerate has a burnt, reddish color, and the sandy matrix is more or less consolidated and indurated. These gravel beds rise upstream and 300 yards west come to the top of the bluff, where they are interbedded with and underlain by brecciated pumice or rhyolitic tuffs. Farther west these in their turn are underlain by other gravel beds, which become more arkose toward the bottom, where they rest on pinkish mica andesite. In each of the conglomerate beds, mingled with the waterworn boulders, there are numerous subangular boulders, some of which are rudely faceted and in outline strongly resemble glaciated boulders. Though none was seen which exhibited striæ or glacial scratches, yet the field observations left the writer convinced that a period of local glaciation antedated the last lava flow in this vicinity. If this glaciation occurred in the headwaters of Alamosa Creek, the carrying of the boulders by the stream to their present site would have worn away the superficial glacial striæ and left them in the condition in which they are now found.

The ledge of pink mica andesite varies from about 30 to more than 70 feet in thickness and is the most persistent and characteristic bed of the eastern border of the west ranges. It furnishes the stone which has been most widely used for building purposes in the valley. It can be quarried in blocks of any desired size, works easily when freshly quarried, hardens on exposure, and has in general a pleasing creamy tint, though varying somewhat in shade in different outcrops. Many public buildings, as well as business blocks and residences, in Antonito, Conejos, La Jara, Manassa, Alamosa, and Monte Vista are constructed of this stone.

Below the pink mica andesite are successive beds of andesite and rhyolitic tuffs and vitrophyres. The following is a section of the various beds from the uppermost sheet of pyroxenite-andesite downward to the pink mica andesite:

---

<sup>a</sup> The various igneous rocks noted herein have been determined by Whitman Cross, of the United States Geological Survey.

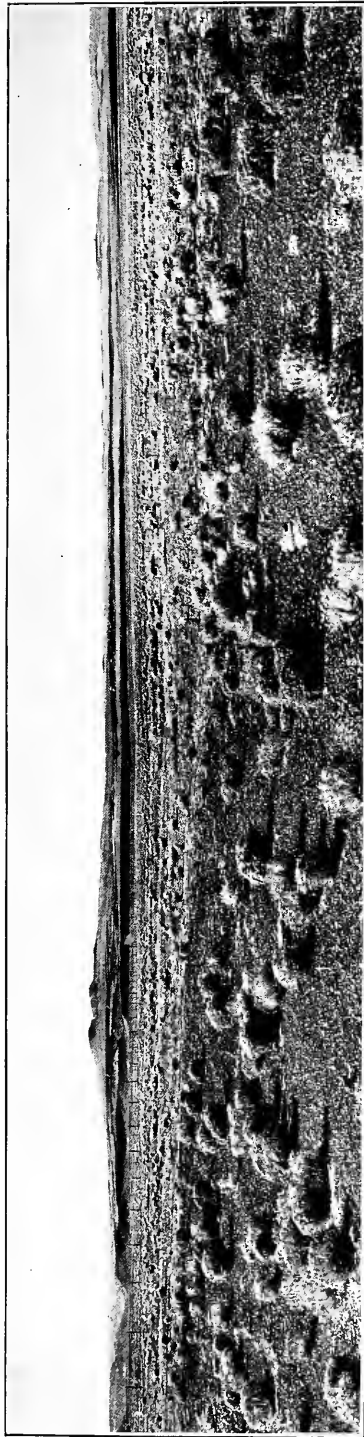

4. VIEW OF LAVA-CAPPED SLOPE DIPPING BENEATH THE VALLEY WEST OF ANTONITO.

Showing characteristic appearance of the Conejos River alluvial fan.

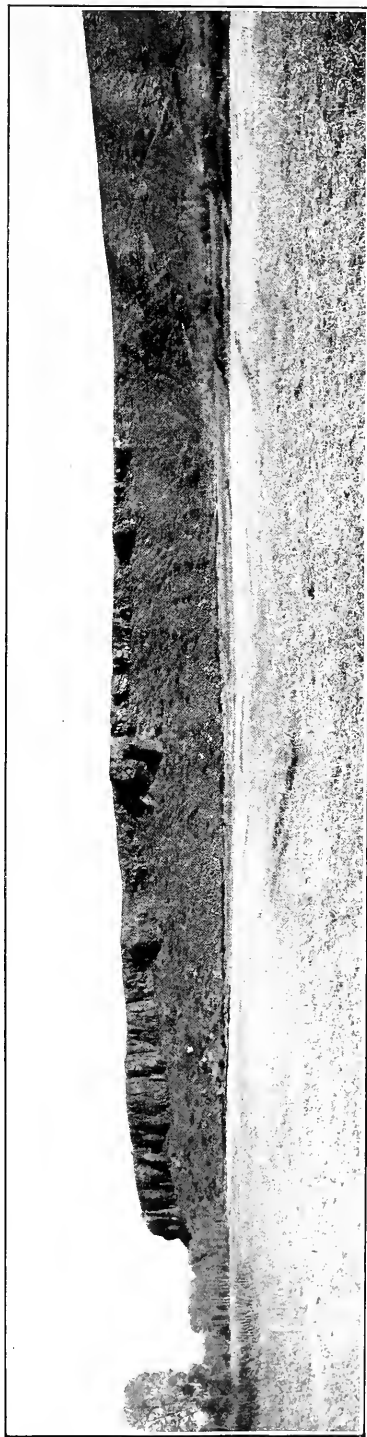

B. BLUFF OF SANTA FE FORMATION ON ALAMOSA CREEK.





*Section of south side of Alamosa Creek canyon, near the lower end.*

	Feet.
Pyroxene andesite; irregular contact at base.....	40
Boulders in sand matrix.....	12
Bedded sand.....	1
Boulders in sand matrix.....	12
Boulders in brecciated pumice tuff.....	3
Boulders with indurated sand matrix.....	1
Boulders and sand; irregular contact at base.....	2
Pumice breccia with small waterworn pebbles.....	2
Sand and boulders of various shapes—angular, subangular, and waterworn.....	4
Pumice breccia.....	14
Concealed, probably gravel.....	8
Brecciated pumice with rounded quartz and felsite pebbles $\frac{1}{8}$ inch in diameter. Upper portion conglomeratic with boulders of various rocks.....	12
Pumice.....	8
Apparently pumice.....	80-100
Bedded gravel and sand becoming lighter in color and arkose toward the bottom.....	50
Pinkish mica andesite.....	40±

## CAT CREEK VALLEY.

The canyon of Cat Creek at the point where it debouches upon the plain is not deep. At the quarry, about a mile up the canyon, the mica andesite first appears, continuing to the forks of the canyon at Tiptons, forming the walls of the south canyon to a point 3 miles beyond, and showing in the walls of the north canyon to the vicinity of Wood's cabin, where the road leaves the canyon and goes up the steep hill. From this it will be seen that the eastward dip of the mica andesite here does not exceed the drainage gradient of Cat Creek, which is a considerably lower dip than the same rock shows in Alamosa Creek.

## ROCK CREEK VALLEY.

In Plate IV, *A*, is shown Painted Rock Bluff along the north bank of Piedra Pintada (Painted Rock) Creek, locally called Rock Creek, which takes its name from the fact that for about a quarter of a mile in the middle of the bluff shown in the photograph the face of the soft andesite bluff is covered with Indian picture writing. The andesite ledge rises westward for a mile and a half to the forks of Rock Creek, where it shows a face of 60 or 80 feet of the pinkish mica andesite, the thickest exposure noted.

These beds of pinkish mica andesite, which appear in the canyons of Alamosa Creek, Cat Creek, and Rock Creek and elsewhere on the west side of the valley, seem to be parts of the same flow or at least to belong to closely related flows in all three canyons. The bed may actually be continuous through the hill from one canyon to the other,

but this is not evident. The high points between the canyons, such as Chiquita Peak, seem to be local extravasations through the andesitic sheet.

#### WEST OF MONTE VISTA.

In the foothills 6 miles west of Monte Vista the flows, dipping eastward more steeply than the slope of the hills, form "hogbacks." Several miles farther west, at the limekiln, a normal fault, bearing N. 30° W., with a throw of 50 or 60 feet to the west, has been prospected through a distance of three-fourths of a mile. Throughout this extent the brecciated fault zone is filled with a vein deposit of calcareous onyx, which has been burned for lime but has not yielded any blocks of onyx marble of commercial size. The width from wall to wall varies from 20 to 40 feet, though at the widest places a portion of the space is taken up by slabs of the country rock, which seem to be either mica andesite or mica rhyolite.

A darker, heavier flow, later than the mica andesite and probably corresponding to the upper flow at the foot of Alamosa Creek canyon, outcrops in a few places, notably near the railway cut midway between Monte Vista and Del Norte, and also in the isolated hill La Loma del Norte, across the Rio Grande, 2 miles east of the last-mentioned exposure.

#### VICINITY OF SAGUACHE.

The eastern edge of the La Garita Hills from Del Norte to Saguache was not examined, but what appears from a distance to be the pink mica andesite occurs in great massive bluffs and makes up a large part of the hills. In the vicinity of Saguache there are a number of small hills of basic lava, the result of local extravasation. The hill near the cemetery southeast of the town is made up of olivine diabase and hornblende andesite. To the northeast, in the vicinity of Hunt Springs, similar hills appear; also farther northeastward to the vicinity of Villa Grove. North and south of that locality, skirting the edges of the foothills, are heavy outcrops of Carboniferous rocks dipping 50° E.

#### AGE OF THE ROCKS INVOLVED IN THE WEST RANGES.

In the discussion of the mesa northwest of San Luis village, the northwest prolongation of the San Pedro Mesa, its equivalence in age with the basic lava capping the lava conglomerate series making up the western ranges is suggested (p. 39). There also is noted the correlation of the San Pedro Mesa and its extension with the lava-capped mesa near Fort Garland, which Hayden, following the formation up the Rio Grande from its type locality, identified as the Santa Fe formation, later shown by Cope to be of Miocene age. This will be assumed, then, to be the age of the alternating series of andesite flows and conglomerates of the eastern border of the western hills.

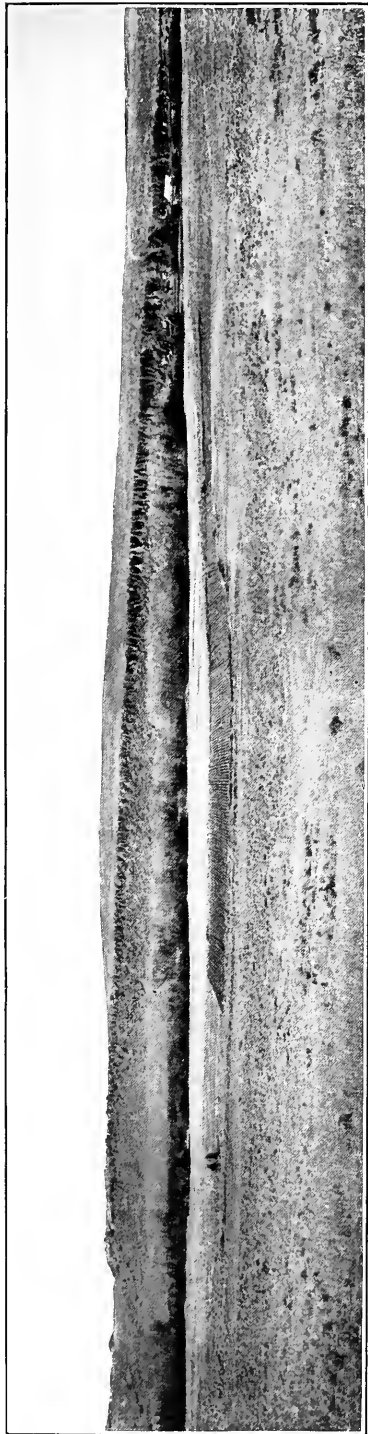

A. PAINTED ROCK BLUFF ON CAT CREEK.

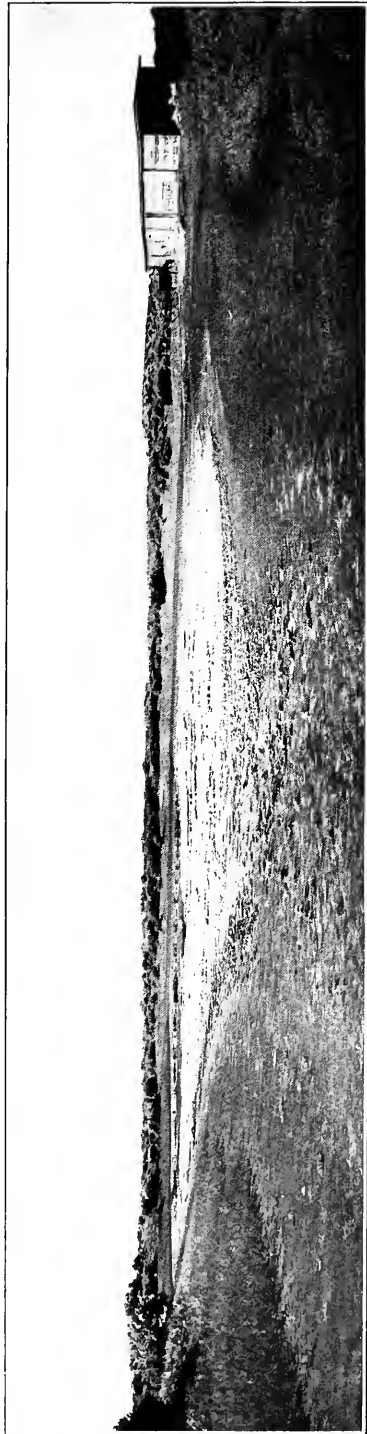

B. SODA LAKE.



Indeed, Hayden <sup>a</sup> noted the occurrence of the Santa Fe formation at the base of the western mountains south of Saguache Creek. The similarity of constitution on the opposite sides of the valley supports the tentative correlation.

#### GLACIATION OF THE WEST RANGES.

While evidence of glaciation in the upper courses of Conejos River and La Jara, Alamosa, Cat, and Rock creeks is plain, the lower limit reached by the ice in each course is difficult to determine. Distinct terminal moraines are not present, but instead the unquestioned drift of the upper courses becomes thinner and less characteristic in the lower courses and may be succeeded by one or two sets of terraces.

The Alamosa Creek glacier manifestly occupied the U-shaped valley of that creek down nearly to the "box canyon," spreading across the flat west of Chiquita Peak into the valley of Cat Creek and coalescing with the ice in that valley. Below the "box canyon" there are two terraces, both developed on the south side of the valley. The lower one, apparently alluvial, is 60 feet high and 100 to 150 yards wide. The upper one, 30 feet higher, is covered with bowlders, in part glacial, and has an irregular surface apparently morainic in origin—an appearance that is borne out by the arrangement of material so far as that can be seen. A mile farther down the creek a third terrace sets in 35 feet high above the valley bottom. Upon the surface of this terrace are two and in places three trains of bowlders, roughly parallel, steeper toward the creek and sloping toward the valley wall. They appear to be morainic in origin, though the occurrence of the alluvial terrace higher up the creek seems to cast doubt upon such interpretation.

In Cat Creek valley the disposition and character of the drift that lies upon the andesite at the quarry near the lower end of the canyon, as well as of that on the sides of the canyon all the way up, seem to point to their deposition directly by the ice. The two forks of the creek occupy trenches cut in the eastward extension of the glaciated flat west of Chiquita Peak. No terminal moraine is apparent.

The headwaters of Rock Creek rise in the rolling glaciated amphitheater shown in Plate II, *B*. In the vicinity of the forks of the creek there is much evidence of glaciation. Parallel to Painted Rock Bluff, but on the south side of Rock Creek, there is a long terrace, steep in front, the gravel-covered surface sloping gently away from the creek. This terrace is in all respects like the uppermost terrace of Alamosa Creek and apparently is lateral morainic in character.

No further evidences of glaciation were noted on the west side of the valley. There are no indications about Del Norte that the Rio

<sup>a</sup> First, Second, and Third Ann. Repts. U. S. Geol. and Geog. Survey Terr., p. 176.

Grande glacier reached that point, and at Saguache there are no signs of glaciation. Though farther west these stream valleys must have held Pleistocene glaciers, the conditions were such that they did not extend as near to the San Luis Valley in this locality as did those farther south.

### THE EAST RANGES.

#### STRATIGRAPHY AND STRUCTURE.

Commencing north of Poncha Pass, the Sangre de Cristo Range forms a true sierra extending southeastward and culminating in the massif of the Sierra Blanca group of peaks. The sky line, formed by a series of pointed peaks with intervals of sharply serrate and jagged crest line, and the precipitous front, rising abruptly from the level plain to the height of a mile, combine to make this range one of the boldest and most majestic in the country.

The geologic boundaries in this range, as laid down on the Hayden map, are very much at fault. Only the most cursory examination has been made of the range, which has been ascended or crossed by geologists but a few times at most. The formations involved, so far as known, are basal gneiss, schists, and granite; intrusive granite; quartz conglomerate; pudding-stone conglomerate and red sandstone; and limestones and shales. The ages assigned to these formations by the Hayden geologists are as follows: Gneisses, schists, etc., Archean; pudding-stone conglomerate and red sandstone, upper Carboniferous; and limestone and shales, lower Carboniferous.

Reference has been made to the occurrence of limestones and sandstones in the vicinity of Villa Grove. The outcrops, as laid down on the Hayden map, show lower Carboniferous rocks facing the valley and upper Carboniferous behind and above. The dip is toward the valley, thus indicating an overturn. On the east side of the valley the same distribution of formations is represented, the upper Carboniferous forming the upper flanks of the Sangre de Cristo Range, the lower Carboniferous restricted to two outcrops on the western foot of the range. This stratigraphic arrangement, taken in connection with the described anticlinal structure of the range, is altogether improbable. Lee has recently shown <sup>a</sup> for the Culebra Range that the limestones marked on the Hayden map as lower Carboniferous are in reality upper Carboniferous and lie on the basal Archean granite, indicating the entire absence of lower Carboniferous; and this is probably true for the whole range except the north end near Salida, where lower Carboniferous limestone carrying fossils with a strong Devonian facies is known. If the same mistake that was made in the Culebra has been made in regard to the age of the limestone east and west of Villa Grove, the structural difficulty disappears and the range is readily interpreted as a great anticline and the valley as a great

<sup>a</sup> Jour. Geology, vol. 10, 1902, pp. 393-396.

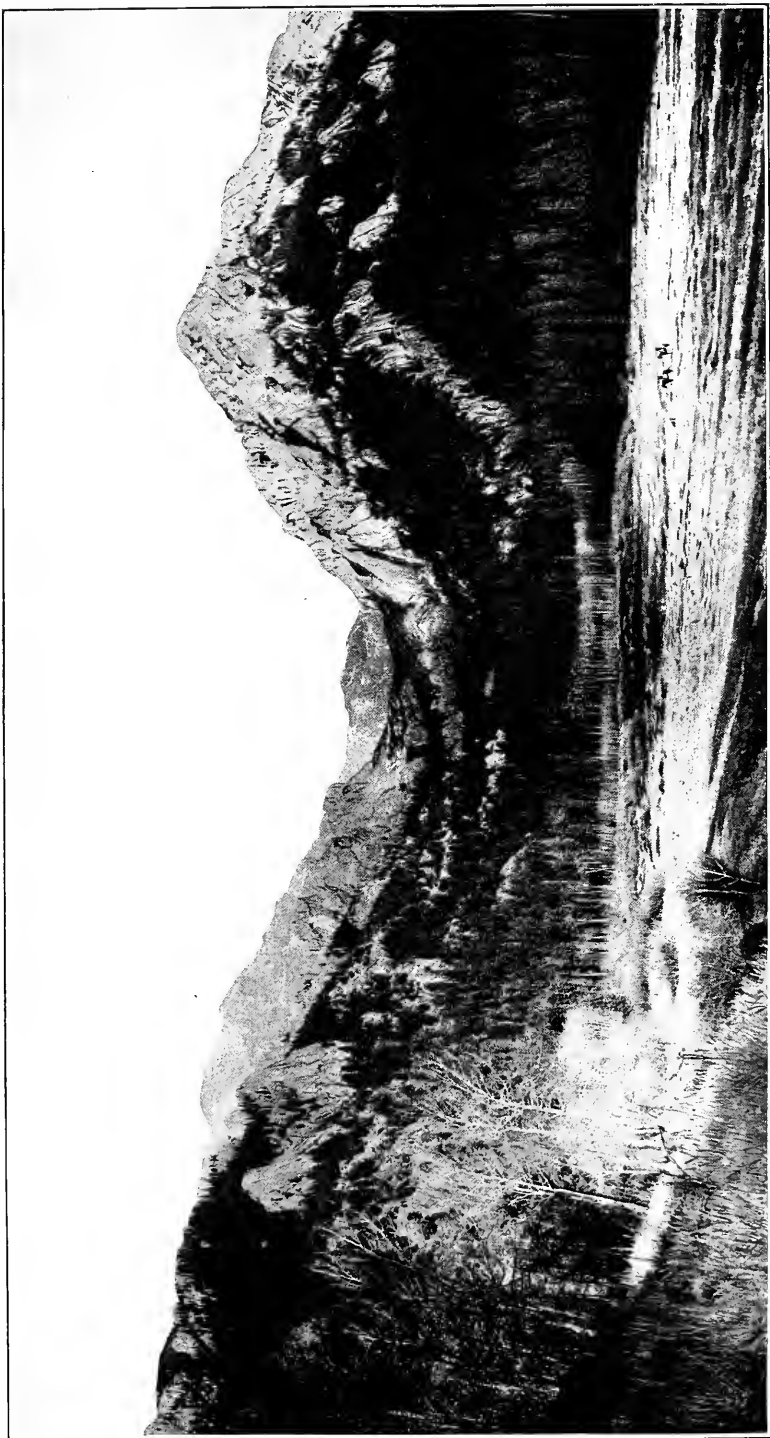

WILLOW CREEK PARK.

A typical gathering ground in Sangre de Cristo Range of streams delivering water to the artesian system.





syncline, the limestone being younger and overlying the sandstones and conglomerates. That the structure of the range is not a simple anticline, however, is well shown by a section up the canyon of Willow Creek, which leaves the mountains 2 miles southeast of Crestone. A view looking up the valley from Willow Creek Park is shown in Plate V. The prominent ledge just beyond the middle of the picture dips south of west  $70^{\circ}$  to  $80^{\circ}$  and consists of conglomerate. This is the formation which was called "Arkansas sandstone" by Endlich and which has here been spoken of as pudding-stone conglomerate because many of the bowlders in the conglomerate are themselves conglomeratic. Some of the bowlders are immense, Emmons <sup>a</sup> noting some 25 to 50 feet in diameter. The pebbles and bowlders are of crystalline rocks of various kinds and colors. Up the valley the dip approaches the vertical, then is inclined the other way, getting lower, and at the head of the valley the structure develops into the possibly faulted syncline shown in Plate VI, reproduced from a photograph taken near and looking toward the crest of the range. The creek from its source to the lower lake, a distance of 3 or 4 miles, flows approximately along the axis of the syncline. There is probably a closely appressed anticline between Willow Creek Park and the syncline just mentioned. The conglomerate extends all the way from the upper end of the park to the crest of the mountain. The texture seems to grow finer upward, becoming practically that of a coarse reddish sandstone at the axis of the syncline, but about the head of the creek the rock is coarsely conglomeratic again. Making allowance for the appressed anticline, the thickness of the conglomerate, as can be seen, is enormous, so that the question of the source and origin of the conglomeratic material may well be difficult, as Emmons found it.<sup>b</sup>

The axis of the range is in general made up of intrusive granite flanked on either side by conglomerate, though the conglomerate extends across the crest of the mountains near Electric Peak and the head of Willow Creek. Beginning north of Crestone, a band of the older granite sets in, widening toward the south until, with the backbone of later intrusive granite, it takes in the whole range, the sedimentary rocks south of Music Pass being restricted to the east foot of the range.

In the saddle between Baldy and Blanca peaks is a bed of conglomerate which is quite different from the conglomerate in the north end of the range, in that the pebbles, which rarely exceed 1 or 2 inches in diameter, are all of pure quartz, while the bowlders of the Carboniferous conglomerate are large and are made up of all sorts of igneous rocks. This conglomerate in the gap has a thickness of a hundred feet or so, rests on the granite, and has a very ferruginous

<sup>a</sup> Bull. Geol. Soc. America, vol. 1, p. 262.

<sup>b</sup>Op. cit., p. 265.

sandy matrix, the reddish color showing at a long distance. Down Ute Creek the conglomerate is more pronounced in character, and it lies against the foot of Baldy Peak upon the truncated edges of steeply dipping and intruded crystalline rocks. Its apparent thickness is over 100 feet, and the dip is  $14^{\circ}$  to  $16^{\circ}$  N.  $15^{\circ}$  E. It stretches away north of Baldy Peak down the valley of Huerfano River, with a dip of  $8^{\circ}$  or  $10^{\circ}$  in a direction north of east. On the north side of the valley the dip of the contact, which from the crumpled condition of the conglomerate seems to be a plane of movement, is  $36^{\circ}$  in a direction south of east. To the east the dip is more gentle,  $20^{\circ}$  in the same direction. In the distance down the north side of the valley can be seen bare white patches of limestone or light shales. No doubt the upward formations succeeding the conglomerate above would be shown in a section down the ridge in the direction of the dip, and perhaps also the relation of the conglomerate to the conglomerates and limestones of the northern part of the range and of Veta Pass. These relations not having been ascertained, the age of this conglomerate must remain for the present undetermined. An apparently similar series of rocks in the Culebra Range just east of San Luis has been described by P. H. and E. C. van Diest, as will be noted below.

Though it is marked on the Hayden maps as Archean, both Hayden and Stevenson pronounced the mass of the Blanca group to be of intrusive rock. For the most part, and particularly in the western portion, it consists of coarsely crystalline granite, without plication or schistosity, but with a system of northeast-southwest joints and fissures. Gneissic and schistose rocks make their appearance along Ute Creek, as noted below. Also, in the lower foothills immediately south of Blanca Peak, the rocks are gneiss or gneissoid granite, the laminae striking northeast and southwest similarly to the veins and fissures in Blanca Peak.

The outcrops in La Veta and Sangre de Cristo passes and to the west, lying as they do on the great highway into the valley, have been noted by Schiel, Hayden, Ruffner, Endlich, and others, and Lee has collected fossils from them. The beds are red sandstone, conglomerates, shales, and limestones. Endlich states that where the sandstones appear from beneath the eastern Cretaceous in the pass they stand nearly vertical but incline to the east, the dip becoming lower toward the central mass of intrusive rock to the west, beyond which the sandstones and limestones set in again, with the dip reversed, and soon pass under the axis of a syncline. Beyond the syncline the limestones are involved in a very acute anticline and the west line of the anticline is faulted so that it abuts squarely against the basal granite. Hayden and Endlich both pronounced these limestones to be upper Carboniferous, and collections by Lee agree



SYNCLINAL VALLEY OF UPPER WILLOW CREEK.

Showing structure of Sangre de Cristo Range and barren character of the upper drainage basins of that range as contrasted with those of the western ranges. (See Pl. II, B.)



with this determination. A similar series, but with different orographic features, is described by Endlich as occurring at the head of Indian Creek. In the ninth report of the Hayden Survey, for 1875, Endlich describes a section (No. VIII) of the east side of the Culebra Range about halfway between Culebra and Trinchera peaks. The lower Carboniferous limestone is represented as lying on the east flank of the granite backbone and overlain in turn by red upper Carboniferous sandstones, whose dip becomes steeper to the east until they disappear beneath the vertical outcrop of Dakota sandstone in "Stonewall" Valley. Lee<sup>a</sup> has shown by a good collection that the limestone is upper Carboniferous and expresses the opinion that the red sandstones belong to the "Red Beds."

E. C. and P. H. van Diest<sup>b</sup> describe a block of quartzites and siliceous limestone faulted against the granite at a locality on the Rito Seco, about 9 miles northeastward from San Luis. The lowest member is a thin bed of conglomerate, composed of light bluish and greenish pebbles of quartz cemented by oxides of iron and manganese. Above this come 160 feet of white saccharoidal quartzites overlain by a thin bed of shale and 200 feet of light-gray siliceous limestones, and those in turn are topped by darker limestones. The fault which throws them against the granite on the east bears N. 35° E. and dips 52½° NW. The formations themselves dip 5° or 6° E., into the mountains. No fossils were found, but on the basis of lithology the authors assign the quartzites to the Cambrian and the limestones to the Silurian.

While developed on a much smaller scale here, the conglomerates as described bear a striking resemblance to those on upper Ute Creek. It will be recalled that farther down the ridge from the outcrop described north of the Huerfano, and overlying it, several bare white spots were noted. It seems altogether probable that these represent a greater development of the limestones overlying the quartzite of the Rito Seco.

Enough has been said to indicate that little is actually known of the geology of the Sangre de Cristo and Culebra ranges and that it is an inviting field for closer study.

#### GLACIATION OF THE EAST RANGES.

The various stream valleys heading against the crest of the Sangre de Cristo Range all held Pleistocene glaciers, the morainic remains of which fall into two systems showing the existence of two periods of glaciation. The moraines ordinarily reach down to about 9,500 to 9,000 feet above sea level and crown the summits of the great alluvial cones that spread out from the mouths of the stream canyons. The moraines of both systems are comparatively fresh looking, and the

<sup>a</sup> Jour. Geology, vol. 10, 1902, pp. 393-396.

<sup>b</sup> Proc. Colorado Sci. Soc., vol. 5, 1894, pp. 76-80.

outer, older ones are not noticeably more eroded than or different topographically from the inner, later ones. Some of the inner moraines are lower, some higher than the outer ones, and though they are generally shorter than the older moraines, some of them, as in Bear Creek valley, transgress the older moraines and extend farther out upon the alluvial slopes, these irregularities being due presumably to varying local climatic conditions in Pleistocene time.

Black Canyon, just east of Orient, has lateral moraines on either side of the valley, 100 to 200 feet high and reaching to the alluvial slope at the mouth of the canyon. A prominent moraine juts out from the Willow Creek canyon, east of Crestone. Behind the moraine is the park or meadow shown in Plate V, the bed of an extinct glacial lake. Two existing glacial lakes are found in the U-shaped valley above the park, as well as striæ, roches moutonnées, and other evidences of ice occupation. South Zapato Creek valley, heading in the Blanca massif, exhibits the same evidences of ice occupation, together with a double crescentic moraine crowning a great alluvial fan at the height of 1,500 feet above the level of the valley. The inner moraine formerly inclosed a small lake, the outlet of which cut through the moraine where it adjoined the canyon wall on the north side and, once incised in the rock, has continued to cut back a narrow winding cleft, through which the water pours, forming the picturesque Zapato Falls. Middle, Bear, Little Bear, Blanca, and Ute creeks, the circle of radiating streams flowing down the west and south sides of Blanca Peak, each held a glacier which came down to and terminated upon the apex of its alluvial fan. At the head of Huerfano Valley, snugly under the northeast face of Blanca Peak, there yet remain two small characteristic glaciers.<sup>a</sup>

The Culebra Range suffered glaciation to a similar extent, according to Willis T. Lee.<sup>b</sup>

#### SAN LUIS HILLS.

Stretching northeastward across the valley from Antonito to Fort Garland is a series of basaltic hills, flat topped and higher west of the Rio Grande, lower and more rounded east of the river, degenerating into a lava-capped mesa, the north border of which forms an escarpment along the south side of Trinchera Creek. At a point 5 miles southwest of Fort Garland this escarpment swings south, joining the San Pedro Mesa at San Luis. These hills and mesas form the southeast limit of the artesian basin, the sand and clay beds of which abut against the older formation, numerous springs coming up along the contact, particularly in the lower course of Conejos River. This

<sup>a</sup> For a fuller description of these glaciers and the Pleistocene glaciation generally see *Jour. Geology*, vol. 15, 1907, pp. 15-22.

<sup>b</sup> Personal communication.

contact in all probability marks a fault scarp, the older strata forming the west ranges and the floor of the valley being deeply downthrown to the northwest in the formation of the depression in which the sands and clays of the artesian system were deposited.

#### THE VALLEY.

In the San Luis Valley there may be distinguished two classes of more or less unconsolidated gravels, sands, and clays, an older series of conglomerates with intercalated lava flows, and a younger overlying series of blue clays with interstratified sand beds.

#### SANTA FE FORMATION.

The older conglomeratic series makes up the small isolated mesas and the higher foothills about Fort Garland and southward along the western base of the Culebra Range, as well as the basalt-covered San Pedro Mesa and its northward continuation which has been mentioned in the discussion of the San Luis Hills. Hayden <sup>a</sup> describes these mesas and refers them to the Santa Fe formation. A thin section of some of the consolidated sands from beneath the lava in the north end of the San Pedro Mesa near San Luis shows, microscopically, a prominent calcareous cement. The sand itself is in part volcanic débris and in part of aqueous origin. The age of the Santa Fe formation has been shown by Cope <sup>b</sup> from well-known and characteristic vertebrate remains to be Miocene. The mesas east and south of Fort Garland are capped by a flow of basalt, while sheets of the same rock are interbedded with the gravels and sands of which the mesas are composed.

A series of deposits northwest of Fort Garland, the "compact drift" of Endlich, <sup>c</sup> deserves notice. A great alluvial fan that formed on the left fork of Ute Creek has been trenched by the creek and shows a succession of terraces. Northwest of Fort Garland a mesa approximately 150 feet high is apparently a portion of this fan, which, with others formed by the other streams that converge at Fort Garland, filled up the angle of the valley between the Blanca group on the northwest and the basalt-capped mesa southeast of Garland. The mesa is covered with a sheet of gravel ranging from pebbles up to bowlders 12 inches in diameter, and is made up of fine buff sand or unindurated sandstone, with here and there a gravel layer consisting of various kinds of crystalline rocks, the whole dipping 10° or 12° E. In the next mesa due west, up the draw, the dip of the soft sandstone is somewhat steeper, ranging from 12° to 22° in a direction north of east. Some of the sandstone beds are quite indurated. No fossils are to be observed. The dip continues on across the mesa for a

<sup>a</sup> Ann. Repts. U. S. Geog. and Geol. Survey Terr., 1867, 1868, and 1869, p. 175.

<sup>b</sup> Ann. Rept. Chief of Engineers for 1874, Appendix FF, p. 127.

<sup>c</sup> Ann. Rept. U. S. Geol. and Geog. Survey Terr., 1875, pp. 149, 222.

mile, but shifts to the south. Toward the west edge of the mesa the high points are composed of igneous rocks projecting through the sands. Within 200 yards of the igneous rock the sandstone becomes more and more bowldery, until in the immediate neighborhood of the igneous rock it is composed almost exclusively of bowlders and all stratification is lost. The igneous rock has not been intruded into the sandstone, for the contact is everywhere such as would result from the deposition of the sandstone upon a surface that had been subject to subaerial weathering. Distinguishing these beds from Tertiary lake beds under the appellation "compact drift," Endlich correlated them with the valley glacial drift of the Sangre de Cristo Range, though believing them to belong to an early stage of the glaciation. Hayden referred them to the Santa Fe formation, and the present writer coincides in that correlation.

Another occurrence of the older material is in the great sand dunes west of Mosca Pass. Endlich <sup>a</sup> regarded the dunes as of recent origin and derived from the drifting sands of the valley, but Hayden <sup>b</sup> referred them to the Santa Fe formation. For the reasons given on page 48, Hayden's is regarded as the true interpretation.

No fossil remains are known to have been found in the Santa Fe formation within the limits of the San Luis Valley, its age determination depending upon localities farther south in the Rio Grande valley.

#### ALAMOSA FORMATION.

To the younger upper series of blue clays with interstratified water-bearing sand beds, which occupy the bottom of the valley proper, the name Alamosa formation has been given,<sup>c</sup> from the town of that name near the center of the valley.

The low relief of the valley region renders natural exposures of the Alamosa formation very scarce, the best one being afforded by Hansen Bluff (Pl. VII, *B*) on the east bank of the Rio Grande, nearly east of the Peter Hansen ranch house.

#### *Section of Alamosa formation in Hansen Bluff.*

Recent:	Feet.
Gravelly slope.....	4
Conglomerate, indurated sandy clay matrix.....	4
Alamosa formation:	
Fine gravel and sand, loose.....	3½
Fine-grained reddish sand.....	2½
Black and red sand.....	½
Drab joint clay, with a great many white indurated nodules.....	1½
Coarse indurated sand and small quartz pebbles.....	4

<sup>a</sup> Ann. Rept. U. S. Geol. and Geog. Survey Terr., 1875, p. 143.

<sup>b</sup> First, Second, and Third Ann. Repts. U. S. Geol. and Geog. Survey Terr., p. 176.

<sup>c</sup> Siebenthal, C. E., *The San Luis Valley, Colorado: Science, new series, vol. 31, No. 802 (May 31, 1910), pp. 744-746.*





A. BUCHER WELL.

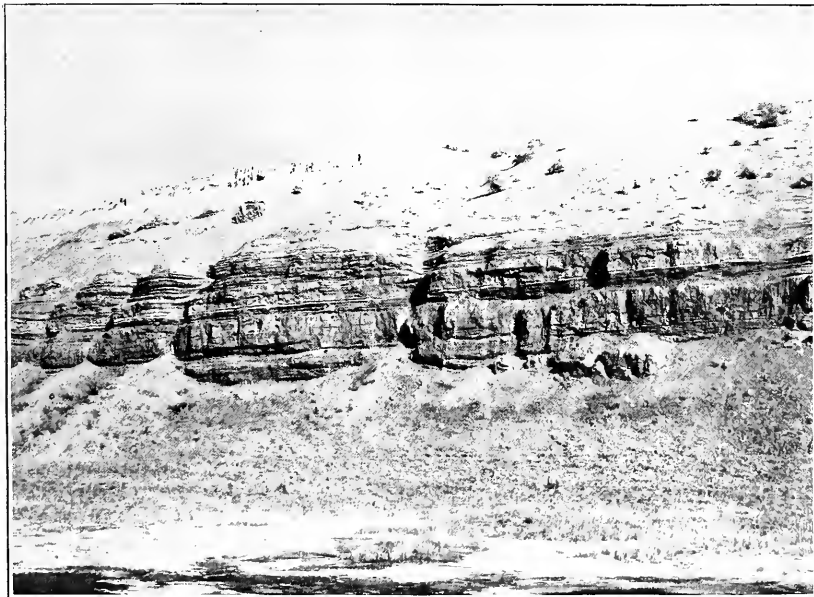

B. HANSEN BLUFF.

Showing stratigraphy of the Alamosa formation.

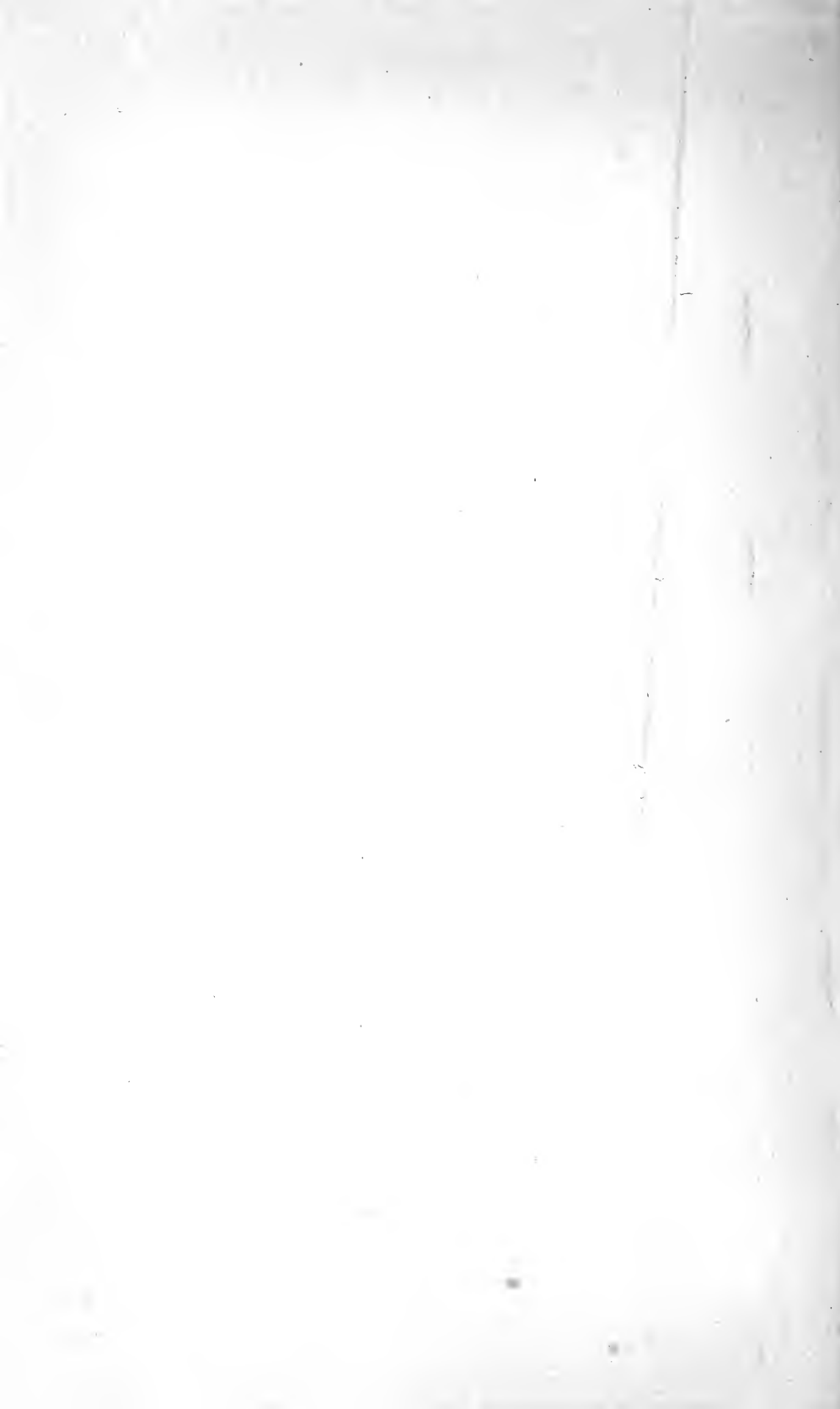

Alamosa formation—Continued.	Feet.
Buff to light-drab sandy clay.....	10½
Fine and coarse sand in laminae.....	5½
Olive-green sandy joint clay, with shells.....	2½
Banded drab sand, with clay pockets.....	1
Fine and coarse pebbly sand in indurated laminae.....	4½
Loose black sand.....	1½
Fine banded clayey sand.....	1½
Coarse sand and clay, with quartz pebbles.....	2½
Débris slope to river.....	12
	61½

The following well section at Alamosa will illustrate this formation to a depth of 725 feet:

*Section of Alamosa formation, from record of Spriesterbach well.*

	Thick- ness.	Depth.
	<i>Feet.</i>	<i>Feet.</i>
Recent:		
Soil and clay.....	3½	3½
Coarse sand.....	15½	19
Alamosa formation:		
Clay.....	2	21
Sand.....	6	27
Clay.....	6	33
Sand.....	3	36
Clay.....	4	40
Sand.....	5	45
Clay.....	11	56
Sand.....	3	59
Clay.....	17	76
Sand.....	1	77
Clay.....	23	100
Lumpy black clay.....	4	104
Clay.....	113	217
Sand (first flow).....	4	221
Clay.....	249	470
Sand (second flow).....	7	477
Very hard clay.....	90	567
Sand (third flow).....	13	580
Hard clay.....	20	600
Very soft sandy clay.....	60	660
Hard clay.....	6	666
Sand (fourth flow).....	30	696
Hard clay.....	14	710
Sand (fifth flow).....	13	723
Hard clay.....	2	725

It is more than likely that minor alternations of sand and clay below a depth of 100 feet have not been taken into account in the record above. The following log of a well on the ranch of Mr. D. E. Newcomb in the SW. ¼ sec. 22, T. 36 N., R. 10 E., will illustrate this point:

*Section of Alamosa formation, from record of well on D. E. Newcomb's ranch.*

	Thick- ness.	Depth.
	<i>Feet.</i>	<i>Feet.</i>
Recent:		
Soil.....	14	14
Gravel.....	8	22
Alamosa formation:		
Light clay.....	30	52
Coarse dark sand.....	11	63
Brittle clay.....	4	67
Blue clay.....	11	78
Fine clay.....	1½	79½

Section of Alamosa formation, from record of well on D. E. Newcomb's ranch—Continued.

	Thick- ness.	Depth.
Alamosa formation—Continued.	<i>Fect.</i>	<i>Fect.</i>
Clay.....	1	80½
Sand.....	½	81
Clay.....	1½	82½
Sand.....	4½	87
Clay.....	4	91
Sand.....	1	92
Clay.....	1	93
Sand.....	½	93½
Blue clay.....	6½	100
Sand.....	1	101
Clay.....	4	105
Sand (strong flow).....	14	119
Hard blue clay.....	5	124
Sand (flow).....	2	126
Clay.....	2	128
Sand.....	1½	129½
Clay.....	3½	133
Sand.....	3	136
Clay.....	4	140
Sand.....	6	146
Clay.....	2	148
Sand.....	7	155
Clay.....	1	156
Sand.....	9	165
Clay.....	5	180
Sand.....	5	185
Clay.....	5	190
Sand.....	10	200
Clay.....	12	212
Sand.....	1	213
Clay.....	2	215
Sand.....	2	217
Clay.....	7	224
Sand.....	2	226
Clay.....	7	233
Sand.....	3	236
Red clay.....	9	245
Sand.....	3	248
Clay.....	1	249
Sand.....	1	250
Clay.....	1	251
Sand.....	7	258
Clay.....	5	263
Sand.....	5	268
Clay.....	3	271
Sand.....	1	272
Clay.....	7	279
Sand.....	3	282
Clay.....	5	287
Sand.....	2	289
Clay.....	1	290
Sand.....	2	292
Clay.....	2	294
Sand (flow).....	12	306
Clay.....	3	309
Sand.....	4	313
Clay.....	14	327
Sand.....	2	329
Clay.....	1	330
Sand.....	7	337
Clay.....	5	342
Sand.....	3	345
Clay.....	2	347
Sand.....	2	349
Clay.....	3	352
Sand.....	6	358
Clay.....	2	360
Sand.....	3	363
Clay.....	5	368
Sand.....	4	372
Clay.....	1	373
Sand.....	½	373½
Clay.....	2½	376
Sand.....	9	385
Gravel.....	3	388
Sand.....	6	394

This well, with over eighty changes in the character of material penetrated in less than 400 feet, will show the impossibility of correlating the well records one with another or of constructing any other than an ideal section of the valley. The multiplicity of wells in the valley, the rapidity and monotony of changes in the formation, and the short time involved in sinking the average well combine to discourage the systematic preservation of well records. Only occasionally, when the person having the well sunk is especially interested, is there any record kept. Most drillers in the valley are perfectly acquainted with their particular field and know beforehand at what depth, within a narrow margin, the desired flows will be found. Several wells are deeper than the Spriesterbach well, but there is only one other deep well with an accurately kept record. The Bucher well at Alamosa is over 1,000 feet deep, the Denver and Rio Grande Railroad well at Moffat is 1,045 feet deep, and the "oil well" east of Mosca is 1,283 feet deep, and several others are over 1,000 feet, but of these there is a record only of the "oil well," which is as follows:

*Section of Alamosa formation, from log of well No. 1, Chicago and San Luis Oil Company, SW.  $\frac{1}{4}$  SE.  $\frac{1}{4}$  sec. 5, T. 39 N, R. 11 E.*

	Thick- ness.	Depth.
	<i>Feet.</i>	<i>Feet.</i>
Recent:		
Sand and clay.....	30	30
Alamosa formation:		
Blue clay.....	4	34
Black sand.....	16	50
Fine sand and clay.....	41	91
Blue clay.....	5	96
Blue clay and fine sand (water, small flow).....	148	244
Blue clay (more water, some gas).....	125	369
Fine white sand (more water, some gas).....	8	377
Hard blue clay.....	9	386
Sand, with bones and shells (flow of gas).....	6	392
Clay shale.....	25	417
Fine sand.....	20	437
Fine green sand.....	5	442
Clay shale, hard, with plentiful shells (gas increasing).....	42	484
Blue clay and sand (strong water, with gas).....	198	682
Blue sand (strong water, with gas).....	53	735
Black sand (strong water, with gas).....	42	777
Hard clay (strong water, with gas).....	26	803
Hard clay, streaks of sand (strong water, with gas).....	84	887
Clay shale (strong water, with gas).....	81	968
Clay and sand (strong water, with gas).....	7	975
Hard blue shale, shells and moss.....	111	1,086
Softer blue shale.....	72	1,158
Harder blue shale.....	68	1,226
Blue shale.....	45	1,271
No record.....	12	1,283

The foregoing sections display as well as possible the constitution of the Alamosa formation. Its contact with the underlying Santa Fe formation, though nowhere exposed, is readily shown to be one of unconformity. Some of the deeper flowing wells to the southwest end in what is called the gravel flow, beyond which the drilling machines used in the valley are not able to go. Still farther south and west, outside of the limit of flowing wells, there are a number

of wells which, after passing through the series of clay and sand beds and a basal gravel bed, penetrate a sheet of lava, below which various gravel and pumice beds are found. Without question the lava and the beds beneath it belong to the Santa Fe formation. The wells of which there are records are too widely scattered to show whether the lava sheet has an erosional configuration or not, but near the point where the Rio Grande enters the San Luis Hills the Alamosa formation abuts against the lavas of those hills at the surface and presumably against the gravel beds of the Santa Fe formation beneath the surface. So, too, the topography exhibited by the foothills of the Culebra Range, composed as they are of the Santa Fe formation, is of a much older type than that of the Alamosa formation.

Though it is impossible to correlate well sections that are any great distance apart, or to trace any stratum of clay or sand from point to point, nevertheless the experience of drillers is that the "first flow" (and by inference, the successive lower flows) in any neighborhood is found at very near the same horizon or depth, gradually increasing in depth toward the center of the valley. For instance, the first flow in the region of Monte Vista is at about 100 feet, near Parma 175 feet, and at Alamosa about 250 feet. Between Center and Hooper the first blue clay is struck at about 80 feet along the entire distance. At Center the first flow, a very small one, is found at 155 feet, at Garnett the first flow is at about 175 feet, and at Hooper and Mosca at about 200 feet. That the uppermost water-bearing bed is covered by a stratum of clay persisting from the center of the valley to the receiving area in the gravelly alluvial slope at the edge of the valley is likewise indicated by the fact that the water is not alkaline. If the bed came to the surface anywhere inside the irrigated area of the valley, it would necessarily absorb more or less alkali from the irrigating waters. Even in the Mosca-Hooper district, where the tinted deeper waters are highly alkaline, the uppermost flow is clear and potable.

The cross section in figure 3, though largely ideal, is based upon all the data available. A fact that comes out in the construction of this section is that wells near the center of the basin show heavy clay beds and fewer aquifers; that wells nearer the margin of the valley, but not too close to it, show thinner clay beds and more aquifers; whereas wells at the limit of the flowing-well area, or outside that line, show but few and thin beds of clay, with sand largely predominating. This is but an expression of the physical limitation of sedimentation. Sand, being coarser and heavier than clay, would be expected to constitute the bulk of the deposits near shore—that is to say, near the edge of the valley—while the finely divided clays would make up the greater volume of the formation in the center of the valley. Beds of sand, thinning toward the center of the valley, pinch out before reaching that region, and beds of clay thin out before

reaching the margin of the basin. Thus the region where both clay and sand beds exist in greatest number is a band of indefinite width which circles the basin some distance inside the margin of the flowing-well area. These features are shown in the diagram (fig. 4). If it be argued that the lower aquifers, having the heaviest pressure, must be confined by clay beds which extend farther up the alluvial slope in the region of intake, it should be remembered that the pressure where the wells are numerous is dependent largely on their number. The deeper the aquifers the fewer are the wells that reach them. Of two aquifers drawing from a common bed of sand in the marginal region, and divided by a clay septum only part way back from the wells, and hence theoretically with identical pressures, the lower one will nevertheless exhibit the higher pressure if the upper one is more drawn upon by wells.

Attention has been called to the great development of alluvial fans and slopes about the sides of the valley. The great Rio Grande fan occupies a fourth or more of the whole extent of the valley bottom. From the figures which have been given of the depth to the first flow at various points on this fan it is evident that the configuration of the uppermost aquifer agrees closely with the surface of the fan, at least within the limits of the artesian basin. The formation of the fan up to the horizon of the upper water-bearing sand must therefore have gone on step for step with the deposition of the Alamosa formation. In other words, the flat alluvial fan of the Rio Grande, with the exception of the gravel veneer, is of sublacustrine deposition, and the fans of the other streams on the west

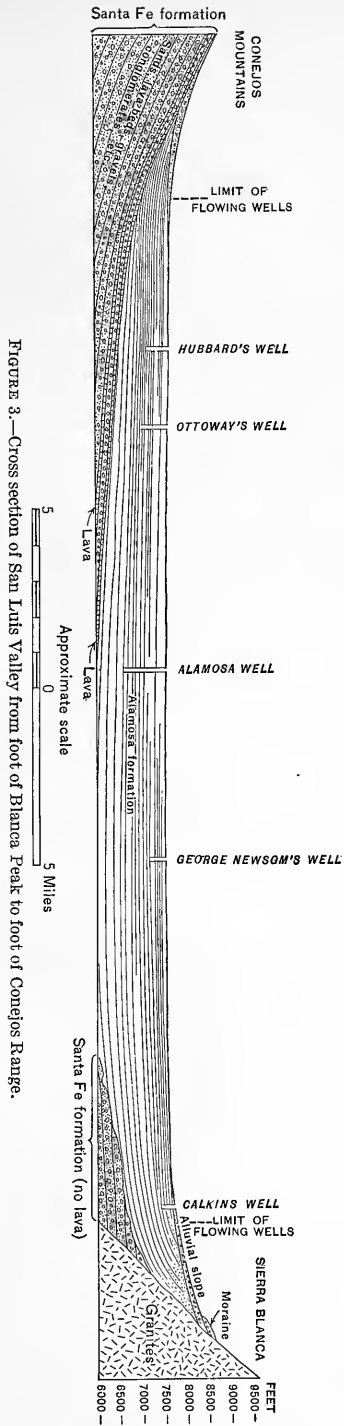

FIGURE 3.—Cross section of San Luis Valley from foot of Blanca Peak to foot of Conejos Range.

side of the valley are largely of the same origin. The persistency and continuity of the thin beds of sand and clay making up the Alamosa formation show that this deposition was in the quiet water of the lake at some distance from the mouths of the streams. Near the stream mouths the sedimentation would naturally take on the shifting character of delta formation. If sediments of this character occur in the Alamosa formation, they are to be expected in the highest part of the fans and on the border of the artesian basin.

Though it does not exhibit the close relation of topography and structure shown by the Rio Grande fan, the alluvial slope along the west base of the Sierra Blanca is nevertheless shown, by the occurrence of artesian water well up the slope, to be made up of the alternating clays and sands of the Alamosa formation. Aside from a certain lack of correspondence, as shown by the topographic map, between the topography and the limit of the flowing-well area, there is no apparent reason for distinguishing between the age of the fans and that of deposits of the valley proper. The deposit of gravel that veneers the upper portion of the alluvial fans and slopes is probably more recent than the body of the fans. The section (fig. 3) and the



FIGURE 4.—Diagram to illustrate the structure of the artesian basin and the alluvial slope and to indicate the relation of the glacial moraines to the slope.

diagram (fig. 4) illustrate how the glacial moraines of the Blanca Mountains are superposed upon the crests of the fans, which are thus plainly shown to antedate the ice period. The moraine of Zapato Creek is especially well calculated to bring out this relation, because, as explained on a previous page, almost all the postglacial erosion of Zapato Creek has been limited to the north edge of the fan, leaving the front of the moraine surmounting the alluvial fan, practically as it was disposed by the advancing ice tongue.

The age of the Alamosa formation is thus seen to be preglacial and post-Miocene. From the Santa Fe formation it was separated by a period of deformation, which was followed by the outpouring of an extensive series of extrusive lavas, followed in turn by an erosion interval of unknown duration. On the other hand, there was apparently no break in sedimentation and no erosion interval between the deposition of the Alamosa formation and the glacial occupation, which was here rather late in the Pleistocene. The logical inference from this is that the formation is of late Pliocene or early Pleistocene age.



As noted in the section of Hansen Bluff on a preceding page, the stratum of olive-green clay yielded a great number of shells. These were referred to Dr. W. H. Dall, who gives the following list of forms:

Planorbis parvus Say.		Lymnæa desidiosa Say.
Planorbis trivolvis Say.		Valvata lewisii Currier.

Occurring with these forms are countless numbers of minute valves of an entomostracan not identified.

Shells similar to these are reported as brought up in drillings all over the valley. Small hollow white bones, also brought up, are usually referred to as "fish bones" or "bird bones." Bits of wood, rootlets, leaves, seeds, and peaty moss are reported from all over the valley, particularly from the Mosca-Hooper district, which yields the tinted water.

The species enumerated above are all fresh-water forms, and while such an assemblage has in general been referred to the Quaternary, it may equally well be referred to the Pliocene and thus offer no inherent objection to the classification of the Alamosa, on stratigraphic grounds, as either late Pliocene or early Pleistocene.

#### QUATERNARY DEPOSITS.

The Recent deposits of the valley comprise sand dunes, alluvial fans, alluvium, and alkali-lake deposits.

#### SAND DUNES.

Incipient dunes occur all over the valley, gathering behind clumps of brush, fence rows, or whatever else offers a wind-break. A particularly sandy area with many small dunes lies south of the Rio Grande between Alamosa and Parma station. Another area lies between Alamosa and Mosca, extending northeastward in the direction of San Luis Lake. The trough of the valley from the railway near Washington Springs northward to Dune station is one succession of small brush-crowned hillocks with interspersed bare places. The latter in the wet season become the sites of ponds and lakelets. Each small lake has an embankment on the north and east shores as a result of the lodgment in the vegetation there of sand picked up by the prevailing southwest wind in its clear sweep across the dry bed and shores of the lake. The San Luis Lakes have such embankments 20 feet high and the Russell Lakes have them in proportion. The alluvial slope at the west base of the Sangre de Cristo Range has much drifting sand and many incipient dunes scattered from Zapato Creek as far north as San Isabel Creek.

The great development of sand dunes, however, is between Medano and Sand creeks, where an area of over 40 square miles is a

solid expanse of dunes, some of which reach great size, as shown in Plate VIII. These dunes consist of rather coarse white quartzitic sand with which is mixed a varying proportion of darker and heavier sand, the latter consisting largely of magnetite, with presumably a proportion of those rare earths ordinarily found in black sands. Several attempts have been made at placer mining in the area but are reported as having been given over on account of the difficulty in bringing water to the deposits. Assays are reported to have shown the darker sands to be high in auriferous magnetite. Be that as it may, it seems undeniable that the sands of the dune area contain a larger proportion of the heavier material than the sand of the valley.

Hayden, as noted, classed the dunes as a remnant of the Santa Fe formation. Endlich<sup>a</sup> advanced the theory that the sand came across the valley from the mountains on the southwest, being driven to its present locality by the prevailing southwest winds, and that it was especially collected in the reentrant angle in the mountain front near Mosca Pass as an effect of eddy currents in the winds, caused by the low gaps in the mountains near this point.

That the sands of the valley are shifting northeastward under the influence of the winds is shown by the long sandy area along the western alluvial slope of the Sangre de Cristo Range and by the embankments of sand on the north and east shores of the lakes and ponds. That the accumulations of the great dune area are so derived is open to question. It has been pointed out that the sand of the dune area averages much heavier than that of the valley in general. In accumulations under such wind transportation and sorting, the reverse would occur. It seems much more reasonable to conclude with Hayden that there was here a remnant of the Santa Fe formation, without the protection of interbedded or overcapping lavas, which has been broken down by the winds, and its sands, whipped now forward and now backward, possibly augmented by contributions from the valley, have been built up into the dunes we now see.

#### ALLUVIAL FANS.

It has already been shown that the alluvial fans and slopes were essentially completed in preglacial time and that they are probably Pliocene or early Pleistocene in age. But over their surface is a covering or veneering of gravel which must have been largely increased in glacial time and since.

In the description of the topography of the valley (p. 11) reference was made to low bluffs or terraces, not now adjacent to streams, which were explained as old courses of the streams or their distributaries abandoned in their wanderings over the alluvial fans. These

---

<sup>a</sup> Ann. Rept. U. S. Geol. and Geog. Survey Terr., 1875, p. 143.



TYPICAL SAND DUNE ON MEDANO RANCH.

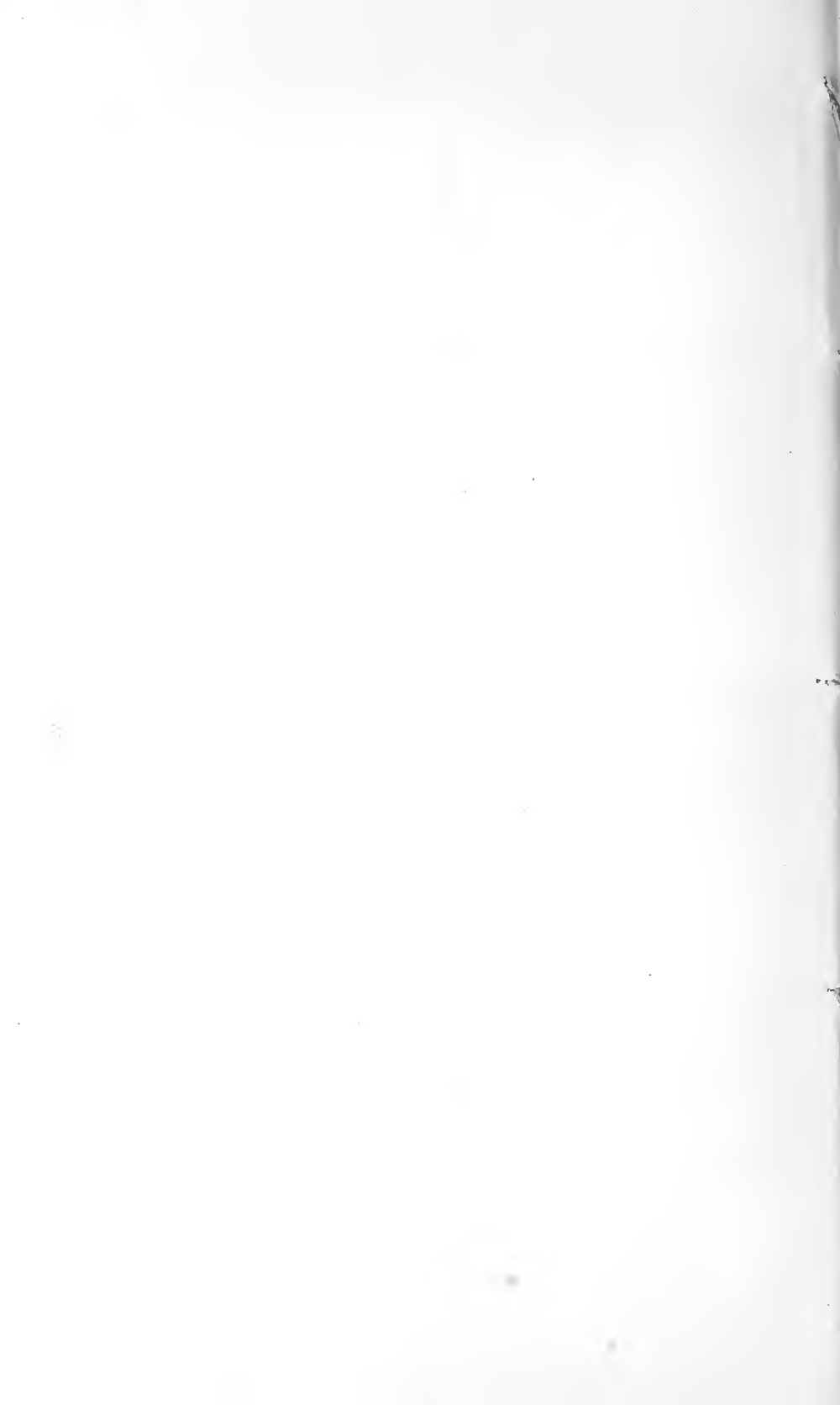

and the configuration of the fan itself seem to have been interpreted by various writers as due to former courses of the Rio Grande. Carpenter <sup>a</sup> alludes to the "ancient course" of the Rio Grande, but does not locate it on the accompanying map. Hinton <sup>b</sup> describes and maps the old course as leaving the present river above Del Norte, skirting the foothills with a due northeast course to the trough of the valley, which it followed southward, uniting with the present course of the Rio Grande near Hansen Bluff. The course northeast from Del Norte, as outlined on the map, corresponds to the north edge of the Rio Grande alluvial fan. Doubtless the Rio Grande or some distributary in times past took the course along the north edge of the fan, just as the river at present occupies a course along the south edge of the fan, and just as it must have occupied all the intervening territory, wandering backward and forward across it. In this way it must have deposited the gravel and sandy covering of the fan, in the fashion which may be seen after a shower where a gully in a steep slope strikes a more level space and the streamlet drops part of its load and builds up a little alluvial fan. But a wrong impression is conveyed by alluding to it as "the" former course if that is meant to imply that the Rio Grande has had but two courses, that one and the present one.

Endlich <sup>c</sup> outlines a former course of the Rio Grande, leaving the present course of that river 3 miles above Alamosa, circling north of Washington Springs, crossing the railroad near Baldy station, crossing Trinchera Creek south of that station, crossing the Rio Culebra about 6 miles west of San Luis, and rejoining the present course some 15 miles below the New Mexico line. A glance at the topographic map will show the utter improbability of this supposition. Baldy station is 60 feet higher than the point on the river where the old course is supposed to leave and the divide south of Trinchera Creek is 50 feet higher still.

#### ALLUVIUM.

Alluvial bottoms occur along the Rio Grande and its various tributaries as well as along the other streams which enter the valley but do not reach that river. The width of the alluvium along the Rio Grande varies from 1 to 2 miles, with here and there reaches of gravelly and sandy loam. The habit of the smaller streams to divide into distributaries reuniting again lower down, forming "sloughs" or "bayous," has a tendency to make the alluvial areas of those streams wider than they would otherwise be.

<sup>a</sup> Bull. Colorado Agr. Coll. Exper. Sta. No. 16, p. 18.

<sup>b</sup> Report on irrigation and the cultivation of the soil thereby: Sen. Ex. Doc. No. 41, 52d Cong., 1 sess., pt. 1, p. 151.

<sup>c</sup> Ann. Rept. U. S. Geol. and Geog. Survey Terr., 1875, pp. 147, 148.

## ALKALI-LAKE DEPOSITS.

There are many small ponds over the valley which in the dry season are pretty well saturated with alkali, exhibiting a white crust along the shore and upon any object projecting above the surface of the water, but in the SW.  $\frac{1}{4}$  SW.  $\frac{1}{4}$  sec. 30, T. 40 N., R. 12 E., 10 miles east-southeast of Hooper, there is a small lake about an acre in extent which is practically solid crystallized sodium carbonate. The lake has the appearance of being frozen and covered with a thin fall of drifted snow. A view of it is shown in Plate-IV, B.

This deposit has been examined by Dr. Herman Fleck, of the Colorado School of Mines, and from his report the following facts are taken by the courtesy of Mr. Mark Woodruff, receiver of Colorado state lands: The soda is quite pure, except for a certain amount of dust, including some organic matter, blown into the deposit by the wind and amounting in the average sample to about 15 per cent. The average thickness of the soda is about 18 inches, with a maximum of 30 to 48 inches, and it is estimated that 4,000 tons of soda remains in sight in the lake. About 500 tons has been raised and shipped. As the soda was removed, the space filled with the mother liquor, from which soda is again crystallizing. How long this would continue and to what extent solid soda exists beneath the surface are questions as yet unanswered. The soda, though originally derived by solution from the crystalline rocks of the mountains, probably has its immediate origin in the clays and soils of the valley, from which it has been leached and concentrated, as are the alkali crusts that trouble the farmer. The reason for the especially strong condensation at this single point probably lay in some topographic relation now altered and concealed by the shifting dunes of this portion of the valley.

W. P. Headden<sup>a</sup> has also examined the soda lake and made analyses of the deposit and the mother liquor, of the surface water and alkali incrustations, and of the tinted alkaline artesian waters of the Mosca-Hooper district. He found that the mother liquor of the soda lake and the tinted artesian waters have the alkalies and other elements in common and in like proportion, differing in those respects from the surface waters and the alkali incrustations. He concludes that the soda deposits have been derived in some way from the tinted artesian waters.

## GEOLOGIC HISTORY OF THE SAN LUIS VALLEY.

The area occupied by the San Luis Valley was originally included in the eastern portion of the Sawatch land mass, the eastern shore line of which corresponded in position to the Sangre de Cristo-Culebra axis. Upon this shore line, through Paleozoic and Mesozoic time, had been

<sup>a</sup> Am. Jour. Sci., 4th ser., vol. 27, 1909, pp. 305-315.

deposited great thicknesses of limestones, sandstones, and conglomerates. As in other places where a shore line received heavy deposits, it became a line of weakness, and succumbing to the pressure was folded by stages into the towering Sangre de Cristo and Culebra ranges. Correlated with the uplift of the range was a depression of the valley apparently either by a synclinal fold, or by a great fault along the west border of the range, or more probably by a combination of the two. The details of the time and the stages of this sequence of events must wait for final solution until the geology of the east and west ranges is more intimately known. Interesting discussions of the orographic development of the Rocky Mountains, incidentally dealing with the history of the San Luis Valley region, have been given by S. F. Emmons and R. C. Hills (see bibliography, p. 8), to whose papers the reader is referred.

The first stage in the history of the valley of which any record is left in the formations of the area is the period when the deposition of the Santa Fe formation began. At this stage the depression consisted of a broad valley limited by the Sangre de Cristo and Culebra ranges on the east and probably extending considerably farther westward than the limits of the present valley. This depression opened to the south along the valley now occupied by the Rio Grande. In this depression in late Miocene time there was laid down the succession of sands, conglomerates, tuffs, andesites, and basalts which make up the Santa Fe formation. At the close of deposition the valley probably presented the appearance of a bolson valley sloping to the center from the height of the San Pedro Mesa, the Garland Mesas, and the great sand dunes on the east side of the valley, and from well up on the range on the west side of the valley. From vents around the west and south margins of the valley that had furnished the flows interbedded with the sands and conglomerates there was poured out on this plain a sheet of dark andesitic lava, which covered the deposits on the west side and over the whole south half of the valley but did not reach those on the east side of the valley north of Fort Garland. Succeeding this flow there was apparently a downwarping of the central valley, with faulting in a northeast-southwest direction in the vicinity of the northwest face of the San Luis Hills, the downthrow being to the northwest and carrying the top of the Santa Fe formation to a depth of more than 1,000 feet in the center of the valley. Accompanying or following these movements was an extrusion of the basaltic cones and table-top mountains which compose the San Luis Hills. Presumably at this time also occurred the extrusion of those masses which, as Los Mogotes Peak, Chiquita Peak, and other prominent points and cones on the west and south sides of the valley, rise above and apparently through the Santa Fe formation; though it is possible that these points mark as well the vents through

which have come some of the interbedded lavas of the Santa Fe formation.

In the depression caused by the down warping in the center of the valley there was formed an extensive fresh-water lake, in which was deposited the series of sands and clays that make up the Alamosa formation. On page 81 it is shown that this sedimentation was interrupted by arid periods, when the lake shrank to a small size, was more or less alkaline, and supported considerable vegetation, principally moss. These deposits of alkali and organic matter, covered by later beds of clay and sand, are the source of the gas and the color of the tinted waters of the Mosca-Hooper district (pp. 81-82).

So far as may be seen, no change in the attitude of the valley has ensued since the close of deposition of the Alamosa formation. When the trough of the valley had been filled with that series of sands and clays to the height of Hansen Bluff the overflow of the lake in which they were deposited had cut down the outlet through the San Luis Hills south of Los Sauces village nearly to the level of the bluff, and the drawing off of the lake followed. Further erosion has cut the outlet some 60 feet deeper and carried away that depth of the Alamosa formation along the Rio Grande adjacent to the bluff.

Nearly one hundred years ago Jacob Fowler, trapper and explorer, entered the San Luis Valley from the south. The following excerpt is the entry made in his journal <sup>a</sup> on the evening of his arrival in the valley. The lines italicized by the present writer show how clearly this observant trapper grasped the character and later geologic history of the valley:

monday 18th Feby 1822

We Sot out Early up the River and at about 12 miles Came to the upper Eand of the High Rocks and going down a gradual decent three or four Hundred yds Came to a low Bottom on the River the Bank being low not more than six or Eight [feet] High the River butifull and a bout one Hundred yds Wide—But all frozen up tite—We Heare got Watter for the Horses—it is Heare proper to Remark that the River as far as We Have Seen it pasing down between the High Rocks or mountains—dose not move in a very gentle manner as It appears much Impeded by the Rocks falling from Each Side, and is forsed forward dashing from one Rock over others In almost one Continued foam the Hole distance threw the mountains Which from What I Can larn is about seventy miles When it appeers below In an oppen Cuntry—I *Have no doubt but the River from the Head of those Rocks up for about one Hundred miles Has once been a lake of about forty to fifty miles Wide and about two Hundred feet deep—and that the running and dashing of the Watter Has Woren a Way the Rocks So as to form the present Chanel—* We this day Crossed a dry Branch. But Have not Seen one Stream of Watter In all the distance We Have Came up on the [west] Side We traveld nor Cold our Horses get one drop of Watter in all that distance but the Eat Snow When the Cold get it.

Stevenson <sup>b</sup> was strongly of the belief that "the whole character here seems to admit of no inference other than that the valley is

<sup>a</sup> The journal of Jacob Fowler, 1821-22, edited by Elliott Cones, New York, 1898, pp. 112-114.

<sup>b</sup> Rept. U. S. Geog. Surveys W. 100th Mer., vol. 3, 1875, pp. 460, 462.



the result of glacial erosion. \* \* \* It seems not impossible that the glacial mass was of equal extent (with the ancient lake) and that in its retreat it delayed for a time, its foot occupying the line marked by the abrupt wall forming the southern boundary of the present basin."

Endlich <sup>a</sup> rejected this view and maintained that the effects of glacial modification were restricted to the immediate edges of the valley, in which limitation the present writer fully concurs. It has been noted in the preceding pages that the valley glaciers in the eastern range reached only to the crests of the alluvial fans and that even in the larger streams of the west ranges they did not reach that far. If, with exceptionally favorable gathering grounds in the high Sangre de Cristo Range, the valley glaciers no more than reached the upper margin of the alluvial slope, it is not probable that a great glacier could gather in the valley.

Since the draining of the lake in which the Alamosa formation was deposited, sedimentation in the valley has been limited to the deposition of alluvium along the valley and of gravel veneering on the alluvial cones and slopes. On the whole, the amount of deposition since the glacial period seems to have been inconsiderable. The Zapato fan, where the discharge of the creek has been confined since glacial time to the north edge, has received no perceptible addition, but rather has been reduced by erosion.

The impression prevails locally that the Sangre de Cristo Range is younger than the mountains west of the valley. This impression has probably arisen from the notion that the level valley is a continuation of the Great Plains east of the Front Range of the Rocky Mountains and that the oceanic waters which deposited the plains formations washed the base of the western ranges until the Sangre de Cristo Range was upheaved and cut the valley off from the sea. Possibly the gentler outline and older aspect of the western ranges have contributed to the impression. It has been made plain in the preceding pages that the western ranges adjacent to the valley are, in part at least, composed of the youngest formation but one in the region, and that this was deposited long after the Sangre de Cristo was elevated. However, the depression of the Santa Fe formation in the center of the valley and certain warping in that formation northwest of Fort Garland may have been accompanied by a further elevation of the Sangre de Cristo Mountains. This possibility is strengthened by the attitude of the lava flows covering the Raton Mesa and others east and south of Trinidad. These flows, according to information communicated by Mr. W. T. Lee, spread over the beveled edges of formations ranging from Dakota to post-Laramie in age and are themselves of Tertiary age. They have been elevated

<sup>a</sup> Ann. Rept. U. S. Geol. and Geog. Survey Terr., 1875, p. 223.

slightly, tilted away from the Culebra Range, indicating a rise of that range, and later dissected. It is reasonable to suppose that the elevation of the range which accompanied the deformation of these Tertiary lavas on the east side was contemporaneous with the deformation of the Santa Fe formation on the west side of the range.

In conclusion, the essential harmony of the local history herein set forth with the general history of the West for the same time may be recapitulated: Miocene deposition, unconformable below, of a series of sands, gravels, and interbedded lavas and tuffs, followed by orographic movements and additional volcanic activity, succeeded by quiet deposition of sands and clays in fresh-water lakes, passing without stratigraphic break into Pleistocene and Recent deposits.

## UNDERGROUND WATERS.

### GENERAL CONSIDERATIONS.

#### PREREQUISITE FEATURES OF AN ARTESIAN SYSTEM.

The essentials of an artesian system are few and simple:

1. An inclined stratum, as of sand, which receives water in the higher portions and transmits it freely to the lower portions.

2. Relatively impervious layers, as clay or shale or finer sand, which confine the water within the water-bearing bed or aquifer.

3. Resistance to lateral escape of the water from the lower parts of the aquifer greater than its resistance to the ascent of water in the well. This may be due to either of several factors, among the commonest of which are—

(a) The bending up of the beds to form the opposite side of a basin.

(b) The thinning out of the water-bearing sand bed or aquifer.

(c) Loss of porosity in the aquifer.

(d) Frictional resistance to lateral movement within the aquifer itself.

(e) Unconformable depositional contact with less pervious beds, as along lower Conejos River.

#### APPLICATION TO THE SAN LUIS VALLEY.

The San Luis Valley is an almost ideal example of the artesian basin. The structure of the valley has been already discussed, and a cross section of the valley is shown in figure 3. The water occurs in beds of fine blue to gray sand varying from 1 to 20 feet or more in thickness, separated from one another by beds of blue clay ranging from 1 foot to several hundred feet in thickness. In the alluvial slope near the base of the mountains at the margin of the valley the clay beds thin out, the lowest ones usually reaching the farthest and highest up the slope, thus giving the greatest pressure to the flows beneath

them, where they are penetrated out in the valley. If all lower openings and avenues of escape in the aquifers were stopped, the water would rise to the level of the receiving area, or, rather, to the lowest point in that area. Thus the water in the strata penetrated at Alamosa would have sufficient head or be under sufficient pressure to rise as high as the margin of the basin about Monte Vista, which would be about 100 feet above the surface at Alamosa. As a matter of fact the head of the Bucher well at Alamosa, the deepest in that vicinity, is not over 56 feet, and the greater number of wells reaching a depth of about 700 feet have a head of less than 40 feet. This loss of head is partly due to the drain upon the water bed by other wells but is probably due chiefly to loss by lateral flow where the sands of the Alamosa formation come into contact with the Santa Fe formation along the northwest margin of the San Luis Hills. In support of this suggestion may be cited the fact that wells near the mouth of Conejos River, in the very lowest portion of the artesian basin, instead of having the very strongest pressure in the valley, as they theoretically should, have on the contrary but small pressures, though very good flows.

#### SOURCE OF THE ARTESIAN WATER.

The source of supply of the artesian water in the San Luis Valley is unquestionably the mountain streams which flow down across the alluvial slope. The disappearance of the mountain streams soon after they reach the alluvial slopes is a matter of common observation. This is particularly true of the streams flowing from the Sangre de Cristo Range. Very few of these streams get beyond the piñons which cover the upper part of the alluvial slope. The same is true of the streams on the west side of the valley, though the greater number of the streams there, being much longer and larger than any in the Sangre de Cristo Range, have sufficient volume of water to stand the loss in passing across the alluvial slope and to send a considerable flow to the Rio Grande, especially in the wet season. But all these streams suffer noticeable loss in the region of the gravel slope.

The largest stream entering from the west is, of course, the Rio Grande, and along this stream various discharge measurements have been made with a view to showing the loss by seepage of this river in various portions of its course through the valley. As shown by these gaging,<sup>a</sup> the actual loss by seepage of the Rio Grande between Del Norte and Monte Vista, a distance of 15 miles, is 75 second-feet. No other section of the river shows a loss at all comparable to this; in fact, the remainder of its course for the most part shows a gain from seepage. Discharge measurements of various other of the principal

---

<sup>a</sup> Bull. Colorado Agr. Coll. No. 48, p. 30.

streams on the west side of the valley have been made from time to time by the state engineer of Colorado, the results of which show like losses in the region of the alluvial slope.

#### ADEQUACY AND PERMANENCY OF SUPPLY.

It has been explained on a previous page that the artesian supply has the first call upon the water of the Rio Grande, inasmuch as one of the large ditches, which has the earliest priority of all, takes its water from the Rio Grande below the section which supplies water to the artesian basin. Since this priority must be satisfied before any water is taken out above, there will always be water flowing across the area which supplies the artesian basin when there is any water in the river at all. This is largely true of the other streams as well. Therefore the artesian basin will always be supplied with water, and any question of failure of wells in the valley will be one of mutual interference as a result of too great concentration of wells, and not one of expansion of the irrigation systems.

#### CAPACITY.

In 1891 Professor Carpenter, estimating 2,000 wells in the valley, with an assumed average flow of 25 gallons per minute, found the total artesian flow to be about 110 second-feet. At 70 acres to the second-foot, this volume of water, if all used, would irrigate 7,700 acres.

Since that year many new deep wells have been bored and older ones sunk to deeper and heavier flows, so that the average flow is now greater than at that time. By actual count, the wells shown on the map and plats herewith number 3,234. The average flow of 1,000 measured and estimated 2 and 3 inch wells, excluding those in towns, amounts to 40 gallons per minute. The wells of the towns have in general much smaller flows than those in the country, but it is believed that the large flows of the wells over 3 inches in diameter, which are not included in the average, will offset the small flows of the town wells, and that the average of 40 gallons is a fair one. Flowing at this average, the 3,234 wells in the valley will yield a volume of water equal to 286 second-feet. At the rate of 70 acres to the second-foot this volume of water will irrigate 20,000 acres. This estimate of the duty of water is probably a minimum. On the average it is perhaps 25 per cent too small, so that 25,000 acres is nearer a true estimate. With adequate storage, this volume of water could be made to irrigate two or three times as great an acreage.

It is practically impossible to estimate the acreage actually irrigated from artesian wells unless a painstaking census be made with that object in view. Even so, it would be impossible to get accurate figures, inasmuch as many persons use the flow of the wells

in connection with the ditch water. In the absence of such actual figures of acreage irrigated from artesian water, some estimate, such as has been made of the possible irrigation from artesian water, must serve. The only wells not used at all in irrigation, a small percentage of all the wells of the valley, are those used for stock purposes. They are scattered here and there over the untilled land, and the water from them usually sinks within a short distance of the well. The larger wells are almost without exception used for purposes of irrigation. In 1904 there were in the valley 76 6-inch wells, with an average flow of over 300 gallons a minute, and 77 wells over 3 inches and under 6 inches in diameter, with an average flow of about 175 gallons a minute. The total flow of these larger wells was approximately 80 second-feet.

However, the true value of artesian water for irrigation purposes is not to be reckoned by the flat acreage it is capable of irrigating. The special value of artesian water lies in the steady, unfailing supply in times of drought when ditch water is wanting.

### FLOWING WELLS.

#### MARGINAL REGION.

#### ALAMOSA AND VICINITY.

This district includes the wells in the town of Alamosa and those southeastward along the Rio Grande for several miles, as well as those north and east of the town, within a radius of 6 or 7 miles. The district contains some of the largest and most of the deep wells in the valley. Within the town itself, covering 1 square mile (Pl. IX), there are 140 wells, the greater number of which are about 700 feet deep or within 50 feet more or less than that depth.

The Bucher well, on the other side of the Rio Grande from Alamosa but in the northeast corner of the same section, is one of the oldest as well as one of the deepest wells in the valley. This well, sunk in 1889, is nearly 1,000 feet deep. The main flow was secured at a depth of 932 feet and the smaller flow at 500 feet, the combined flow in 1891 being reported by Professor Carpenter to be about 600 gallons a minute, or  $1\frac{1}{3}$  second-feet. The diameter of the well is 6 inches at the bottom. Reduced to 3 inches, it throws a jet of water 48 inches high. The temperature is  $74.7^{\circ}$ <sup>a</sup>, according to Professor Carpenter, who reports that the pressure indicates a head of 56 feet. No record was kept of the geologic section of the well. Analyses of the water are given in the table of analyses on page 112. The water is without taste, like that of shallower flows. It is caught in a large reservoir and used in a small way for irrigation. A view of this well is shown in Plate VII, A.

---

<sup>a</sup> All temperatures here given are expressed in degrees Fahrenheit.

The town well, situated in the northwest corner of Alamosa, a mile west of the Bucher well, is 865 feet deep and 6 inches in diameter and is cased to a depth of 852 feet. The flow in 1891, as measured by Professor Carpenter, was 400 gallons a minute. The temperature is 72° F. The water from this well, with additions from the various private wells, is carried in ditches through the streets of the town, irrigating the shade trees and grass plats along the way. The following is a condensed record of the well:

*Record of Alamosa town well.*

	Thick- ness.	Depth.
	<i>Fect.</i>	<i>Fect.</i>
Recent:		
Alluvial soil.....	3	3
Sand.....	10	13
Alamosa formation:		
Blue clay.....	511	524
Black sand (flow).....	2	526
Blue clay.....	324	850
Black sand (strong flow).....	15	865

The Denver and Rio Grande Railroad well at the water tank is 938 feet deep and 4 inches in diameter at the bottom. It has a flow of 60 gallons a minute at the surface of the ground, or 20 gallons a minute where it empties into the tank at a height of 37 feet above the ground. The pressure, when finished, indicated a head of 46 feet. A small flow was struck at 630 feet, and at 838 feet a flow of 90 gallons a minute, the pressure of which indicated a head of 32 feet. The purpose of going on to the deeper though smaller flow was to get sufficient head to lift the water into the top of the water tank at 37 feet. The flow at 937 feet is the same flow that is struck by the Bucher well. These two are the only wells having this flow in the vicinity of Alamosa, though there are a few other wells deep enough to reach it. The log of the well is as follows:

*Record of Denver and Rio Grande Railroad well.*

	Thick- ness.	Depth.
	<i>Fect.</i>	<i>Fect.</i>
Recent:		
Soil.....	3	3
Sand.....	15	18
Alamosa formation:		
Clay.....	3	21
Sand.....	9	30
Clay.....	18	48
Sand.....	6	54
Light clay with streaks of sand.....	296	350
Blue clay with some sand strata.....	280	630
Sand (small flow).....	2	632
Clay with some sand strata.....	206	838
Sand (strong flow).....	10	848
Hard clay.....	72	920
Sand (flow).....	2	922
Hard clay.....	13	935
Hard layer.....	2	937
Sand and gravel (strong flow).....		



PLAT OF ALAMOSA, SHOWING LOCATION OF WELLS.





The Goodall well, 400 feet southeast of the Bucher well, is reported to have this section:

*Record of Goodall well.*

	Thick- ness.	Depth.
	<i>Feet.</i>	<i>Feet.</i>
Recent: Surface gravel and sand .....	40	40
Alamosa formation:		
Yellow clay .....	15	55
Black sand .....	1	56
Blue clay .....	204	260
Black sand (first flow, light) .....	1	261
Blue clay .....	245	506
Black sand (second flow, light) .....	1	507
Blue clay .....	109	616
Black sand (third flow, light) .....	1	617
Blue clay .....	159	776
Red sand (fourth flow, good) .....	10	786
Blue clay .....	90	876
Red sand and small gravel (fifth flow, good) .....	7	883

This well is 3 inches in diameter and the temperature is 70°. The flow is the large one struck in the town well and at 838 feet in the Denver and Rio Grande Railroad well at the water tank.

The Spriesterbach well, in the northern part of Alamosa, 725 feet deep and 3 inches in diameter, has a temperature of 66°. The well has recently failed considerably. It seems likely, as indicated by the temperature, that the water is coming from a flow somewhat above the bottom. The detailed geologic section of this well has been given on page 41. Analysis shows the water to contain 295 parts per million total solids.

The Hirst well, in the southern part of Alamosa, is 4 inches in diameter, 820 feet in depth, and cased to bottom. The following flows are reported:

First flow, 220 feet, stream size of lead pencil.

Second flow, 475 feet, stream 1 inch in diameter.

Third flow, 680 feet, good flow.

Fourth flow, 800 feet, heavy flow in 8-10 feet red sand.

The Alamosa Milling and Elevator Company's well is 4 inches in diameter and 680 feet deep, cased to the bottom. The temperature of this well is 69° and that of a deeper 3-inch well is 72°. An analysis of the water will be found in the table of analyses, page 112.

At the electric-light plant there is a well cased 6 inches for some distance and 4 inches to the bottom at 800+ feet. The temperature is 73°.

The Fritz Emperius well is a mile and a half southeast of Alamosa, in the NW.  $\frac{1}{4}$  sec. 13, T. 37 N., R. 10 E. The depth is 810 feet, cased to the bottom, and the diameter is 4 $\frac{1}{2}$  inches. The temperature is 72° and the flow forms a jet 7 $\frac{1}{2}$  inches above the casing. The flow is estimated to be about 350 gallons a minute and, stored in a reservoir, will irrigate 50 acres. The cost was \$950.

The Wilkins well, a mile southeast of Alamosa, in the SE.  $\frac{1}{4}$  sec. 14, T. 37 N., R. 10 E., is 800 feet deep, cased to the bottom, and is 5 $\frac{1}{2}$  inches in diameter. It is reported to have a flow rising 7 inches above the casing. The temperature is 72°.

Three miles down the Rio Grande from Alamosa, on the Wilkins, Schwartz, and Worcester ranches, there are several 4, 4 $\frac{1}{2}$ , and 5 inch wells that have good flows.

At the Blanca farm, 4 miles north of Alamosa, in the southeast corner of the NE.  $\frac{1}{4}$  sec. 21, T. 38 N., R. 10 E., there is a 3-inch well, 840 feet deep, cased to the bottom. The flow, struck in gravel, throws a jet 6 $\frac{1}{2}$  inches above the casing, and is estimated to be 130 gallons per minute. The temperature is 72° and there is a slight taste of sulphur. The analysis of the water is given in the table on page 112.

On George Newsom's ranch, 5 miles northeast of Alamosa, in the SW.  $\frac{1}{4}$  sec. 33, T. 38 N., R. 11 E., there are eight 3-inch wells, two 4-inch wells, and one 6-inch well, all with fair flows. The geologic section, which is typical for this vicinity, is as follows:

*Section of Newsom wells.*

	Thick- ness.	Depth.
Recent:	<i>Ft. in.</i>	<i>Feet.</i>
Soil and clay.....	16	16
Gravel and sand (cased to this level).....	10	26
Alamosa formation:		
Clay.....	74	100
Sand (first flow).....	4	100
Clay.....	25	125
Sand (second flow).....	5	126
Clay.....	34	160
Sand (third flow).....	1	161
Clay.....	64	225
Sand (fourth flow).....	1	226
Clay.....	124	350
Sand (fifth flow).....	2	352
Clay.....	48	400
Sand (sixth flow).....	4	404

**HENRY STATION AND VICINITY.**

This district is characterized by the greatest number of wells of large bore in the valley. The number of 6-inch wells in this vicinity and westward in the Fountain neighborhood is over 50, and in addition there are several 4-inch and 5-inch wells. All these larger wells have been put down for purposes of irrigation, many of them recently. Twelve of these have been recently put down on the Empire farm of the Southern Colorado Land Company, in the immediate vicinity of Henry station. The following section of one of these is typical of the region:



A. SIX-INCH WELL ON EMPIRE FARM.



B. KINCH WELL.



*Section of Empire farm well.*

	Thick- ness.	Depth.
	<i>Fect.</i>	<i>Fect.</i>
Recent: Surface gravel and loam.....	11	11
Alamosa formation:		
Clay.....	69	80
Sand (small flow).....	3	80½
Clay.....	59½	140
Sand (flow).....	2	142
Clay.....	38	180
Sand (flow).....	3	183
Clay.....	57	240
Sand (flow).....	3	243
Clay with various beds of sand.....	194	437
Sand (flow).....	3	440
Clay.....	40	480
Gravel below ("gravel" flow, strong).		

Another well on the same farm, by a different driller, gives this record:

*Section of Empire farm well.*

	Thick- ness.	Depth.
	<i>Fect.</i>	<i>Fect.</i>
Recent: Gravel.....	17	17
Alamosa formation:		
Clay.....	53	70
Sand (first flow).....	1	71
Clay.....	54	125
Sand (second flow).....	1	126
Clay with water-bearing sand beds every 20 feet.....	324	450
Gravel (gravel flow).....	3	453
Clay.....	50-90	500-545
Boulders below (strong flow).		

This boulder bed is reached at a depth of 500 feet on the west side of the ranch, and at a depth of 545 feet on the east side. A typical view of one of these wells in winter is shown in Plate X, A. The casing is cut off close to the ground so that the water will not dig out a great hole around the well, as it would if the casing extended far above the ground.

Two 6-inch wells on the Mitchell ranch, in the SE. ¼ sec. 33, T. 37 N., R. 10 E., have depths of 540 and 575 feet. Each throws a 3-inch jet and together the flow is 1½ second-feet, irrigating 100 acres. They are cased only to the first clay and the total cost of both was \$233.

A well on the Adams ranch, 3 miles due east of Henry station, in the southeast corner of the SW. ¼ sec. 35, T. 37 N., R. 10 E., furnishes the following section:

*Section of Adams well.*

	Thick- ness.	Depth.
	<i>Fect.</i>	<i>Fect.</i>
Recent: Surface gravel and loam.....	20	20
Alamosa formation:		
Clay.....	40	60
Sand.....	1	61
Clay, with water-bearing sand beds 2 feet or so in thickness about every 40 feet.....	619	680
Gravel below (heavy flow).		

This well, 6 inches in diameter, bored in November, 1892, is reported to have had originally a jet 9 inches high. By 1904 the jet was reduced to  $3\frac{1}{2}$  inches.

On the J. W. Kinch place, in the NE.  $\frac{1}{4}$  sec. 9, T. 36 N., R. 9 E., a 6-inch well, when new, had a jet of 12 inches, which is now reduced to  $5\frac{1}{2}$  inches. A section of this well is as follows:

*Section of Kinch well.*

	Thick- ness.	Depth.
	<i>Feet.</i>	<i>Feet.</i>
Recent: Surface gravel and loam.....	14	14
Alamosa formation:		
Clay.....	66	80
Black sand (first flow).....	1	81
Clay.....	44	125
Sand (second flow).....	2	127
Clay, with water-bearing sand beds 2 to 4 feet thick every 40 or 50 feet.....	260	387
Gravel and coarse sand (gravel flow).....	15	402

This well is shown in Plate X, B.

**FOUNTAIN NEIGHBORHOOD.**

In the SE.  $\frac{1}{4}$  sec. 16, T. 37 N., R. 9 E., on the place owned by George Ottaway, there are two 6-inch wells, dug in 1900 and 1901. The south well, 585 feet deep, has this section:

*Section of Ottaway well.*

	Thick- ness.	Depth.
	<i>Feet.</i>	<i>Feet.</i>
Recent: Surface clay and gravel.....	14	14
Alamosa formation:		
Blue clay.....	106	120
Sand (first flow, very weak).....	1	121
Blue clay.....	189	310
Sand (fair flow; 4 feet head).....	2	312
Blue clay.....	40	352
Sand (flow).....	2	354
Blue clay.....	40	394
Sand (flow).....	2	396
Blue clay.....	100	496
Sand (flow).....	2	498
Blue clay.....	38	536
Sand (flow).....	2	538
Blue clay.....	17	555
Hard yellow clay.....	20	575
Gravel (gravel flow).....	10	585

These wells are reported to have had jets of  $5\frac{1}{2}$  inches when first put down, but they are now reduced to 2 inches. The temperature is  $64^{\circ}$  and the two wells irrigate 160 acres.

When wells are sunk to the gravel flow in this vicinity the water runs out at the top of the drill rods 22 feet above the surface of the ground, showing a head of that much or more.

The well on the Hubbard place, in the southwest corner of the NE.  $\frac{1}{4}$  sec. 9, T. 37 N., R. 9 E., has the following section:

*Record of Hubbard well.*

	Thick- ness.	Depth.
	<i>Feet.</i>	<i>Feet.</i>
Recent: Surface clay and gravel.....	16	16
Alamosa formation:		
White clay.....	44	60
Blue clay.....	80	140
Hard streak.....	1	411
Sand (first flow).....	1	142
Soft mud.....	24	166
Sand (second flow).....	1	167
Blue clay.....	34	201
Sand (third flow).....	1	202
Blue clay.....	119	321
Red sand (fourth flow; heavy).....	1 $\frac{1}{2}$	322 $\frac{1}{2}$
Blue clay.....	42 $\frac{1}{2}$	365
Sand (fifth flow).....	2	367
Blue clay.....	63	430
Sand (sixth flow).....	2	432
Blue clay.....	8	440
Sand (seventh flow).....	2	442
Hardpan.....	3	445
Blue clay.....	35	480
Gravel (eighth flow; gravel flow).....	2	482

This vicinity was one of the earliest in which artesian wells were sunk for irrigation on an extensive scale, and now over 2,000 acres are irrigated from wells alone, besides which much artesian water is turned into the ditches and used in conjunction with the ditch water.

**LA JARA AND VICINITY.**

The wells of the La Jara district are of moderate depth and very strong flow. In the town itself there are 71 wells, the distribution of which is shown in figure 5. These range in depth from 65 to more than 300 feet. The following section is reported to be typical:

*Section of well at La Jara.*

	Thick- ness.	Depth.
	<i>Feet.</i>	<i>Feet.</i>
Recent: Soil and gravel.....	30	30
Alamosa formation:		
Blue clay.....	15	45
Black sand (first flow).....	1	46
Blue clay.....	19	65
Black sand (second flow).....	3	68
Blue clay.....	17	85
Red sand (third flow).....	2	87
Blue clay.....	16	103
Red sand (fourth flow).....	2	105
Blue clay.....	15	120
Red sand (fifth flow).....	2	122
Blue clay.....	10	132
Red sand (sixth flow).....	2	134
Blue clay.....	11	145
Red sand (seventh flow).....	1	146
Blue clay.....	14	160
Red sand (heavy flow).....	3	163
Blue clay.....	17	180
Red sand (ninth flow).....	3	183
Blue clay.....	10	193
Red sand (tenth flow).....	3	196
Blue clay.....	3	199
Gravel (eleventh flow).....	17	216
Clay.....	12	228
Sand (twelfth flow).....	5	233

The ninth flow has a head of 12 feet, which formerly was 16 or 18 feet; the tenth flow has a head of 15 feet.

The well of the La Jara Milling and Elevator Company has a depth of 308 feet, a diameter of  $4\frac{1}{2}$  inches, and a temperature of  $48^{\circ}$ . An analysis of the water from this well may be found in the table of analyses, page 112.

The well at the residence of L. A. Norland is  $4\frac{1}{2}$  inches in diameter and 325 feet in depth, cased to 300 feet. The temperature is  $49\frac{1}{2}^{\circ}$ .

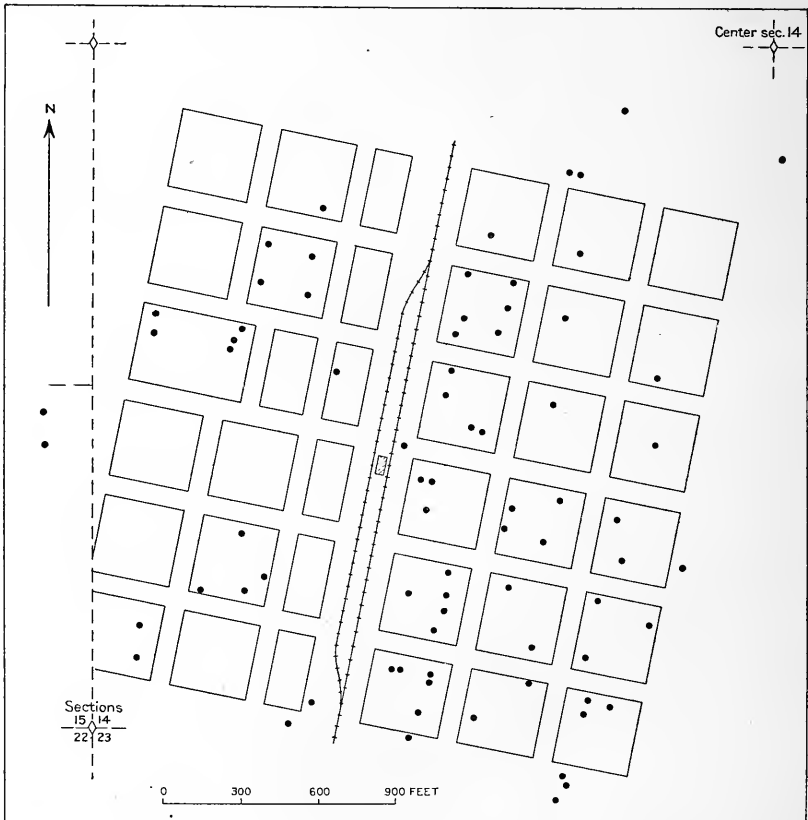

FIGURE 5.—Plat of La Jara, showing location of wells.

Reduced to 3 inches it throws a jet 18 inches high; reduced to 2 inches it throws a jet 7 feet high. The jet for the full aperture of the well is about 3 inches.

On the ranch of William Lambert, 1 mile north and 1 mile west of La Jara, a well 210 feet in depth gives this section:



*Section of Lambert well.*

	Thick-ness.	Depth.
	<i>Fcet.</i>	<i>Fcet.</i>
Recent: Gravel and sand.....	18	18
Alamo $\acute{o}$ a formation:		
Clay.....	109	127
Sand (first flow).....	1	128
Clay.....	19	147
Sand (second flow).....	1	148
Clay.....	39	187
Sand (third flow).....	1	188
Clay.....	22	210
Solid rock below.....		

This well is not included in the series extending eastward from Capulin, as described on page 95, because the water was struck in the water-bearing beds of the basin and not in the lava, as in those wells. Furthermore, it is possible, though not probable,

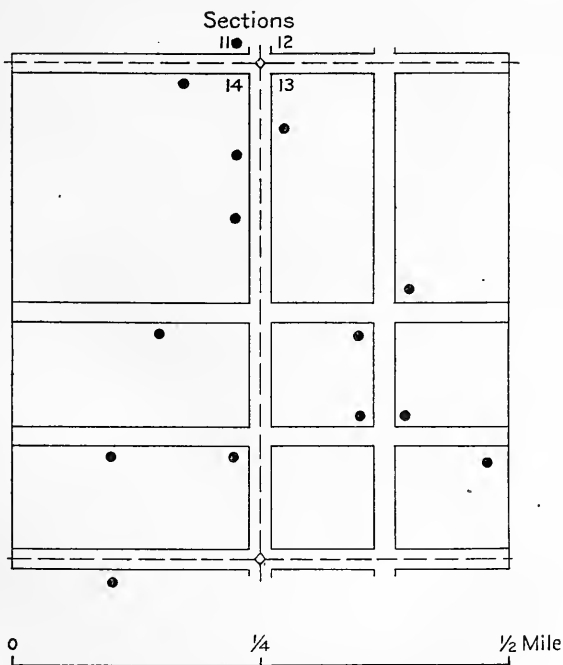

FIGURE 6.—Plat of Richfield, showing location of wells.

that the rock struck in this particular well may have been a large boulder.

The plat of the village of Richfield (fig. 6), half a mile northeast of La Jara, shows the location and number of wells in that place.

## SANFORD AND VICINITY.

A plat of the town of Sanford, which covers  $1\frac{1}{2}$  sections, is shown in figure 7. The blocks are 220 yards from street to street, and each block in the more closely settled portions of the town contains from one to four wells. Most of these are shallow, ranging in depth from

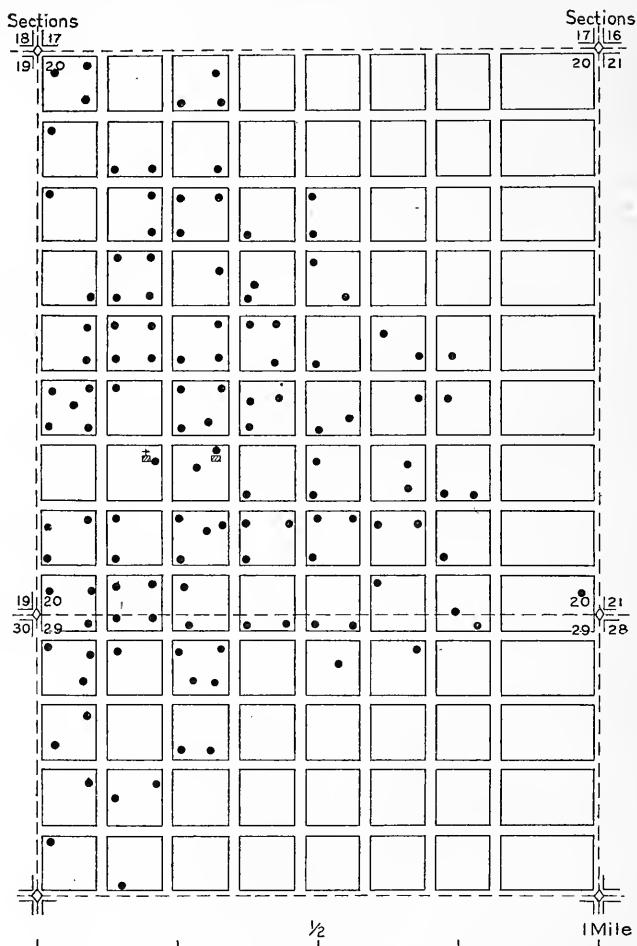

FIGURE 7.—Plat of Sanford, showing location of wells.

70 to 200 feet, and nearly all are 2 inches in diameter. Many wells which formerly obtained the first flow at 70 feet have since had to be sunk deeper, owing to the exhaustion of the first flow by mutual interference of the wells, which number 126 in the village. The following section is given as typical of these wells:

*Characteristic well section at Sanford.*

	Thick- ness.	Depth.
	<i>Feet.</i>	<i>Feet.</i>
Recent:		
Soil and gravel.....	22	22
Sand.....	12	34
Alamosa formation:		
Blue clay.....	36	70
Black sand (first flow).....	2	72
Blue clay.....	23	95
Red sand (second flow).....	2	97
Blue clay.....	13	110
Red sand (third flow).....	2	112
Blue clay.....	11	123
Red sand (fourth flow).....	3	126
Blue clay.....	19	145
Red sand (fifth flow).....	1	146
Blue clay.....	19	165
Red sand (sixth flow).....	1	166
Blue clay.....	19	185
Red sand (seventh flow).....	2	187

VICINITY OF LOS SAUCES.

The little Mexican plaza, Los Sauces, lies a mile or so south of the artesian limit, but a number of wells on the Atkinson, Austin, Stewart, Myers, Becker, and Hansen ranches lie nearer to Los Sauces than to any other post-office in the valley.

On the Peter Hansen ranch there are a number of 2 and 3 inch wells which have good flows. The depth ranges from 200 to 300 feet, and the water has a temperature of 53° to 55°.

On Fritz Becker's ranch a well in the NE. ¼ sec. 15, T. 36 N., R. 11 E., flows about 26 gallons a minute. It has the following section:

*Section of Becker well.*

	Thick- ness.	Depth.
	<i>Feet.</i>	<i>Feet.</i>
Alamosa formation:		
Sand and clay.....	39	39
Hard streak.....	1	40
Sand (flow).....	1	41
Clay with hard streaks.....	127	168
Sand (flow).....	1	169

On W. H. Myers's lower ranch on Trinchera Creek, 4 miles above the mouth of the creek, near the eastern limit of flowing wells, six wells have been sunk which have yielded small flows. One of these near the house, 300 feet deep, had the following section:

*Section of Myers well.*

	Thick- ness.	Depth.
	<i>Feet.</i>	<i>Feet.</i>
Recent:		
Soil and sand.....	16	16
Gravel.....	2	18
Alamosa formation:		
Clay.....	40	58
Clay and sand.....	82	140
Fine gravel (small flow).....	5	145
Clay and sand (no further flow).....	155	300

On the Stewart ranch, opposite the mouth of Trinchera Creek, several 3-inch wells, 170 to 300 feet deep, have good flows and are utilized in irrigating hay land.

On the Austin ranch, at the mouth of the Conejos, are a number of 2, 3, and 4 inch wells which have unexpectedly small flows, considering that they are at the very lowest point in the artesian basin. It has been already shown that this small flow is in all probability due to the escape of the water from the artesian water beds into the gravel beds of the Santa Fe formation.

On the Atkinson ranch, in the NW.  $\frac{1}{4}$  sec. 9, T. 35 N., R. 11 E., there are several 2-inch wells from 125 to 140 feet deep. Three of these wells were sunk at a total cost, exclusive of casing, of \$35. One of them has a flow of 65 gallons. The first flow, a small one, was reached at a depth of 33 feet.

#### PARMA AND VICINITY.

The big well on the Parma Land Company's farm, in the southeast corner of sec. 14, T. 38 N., R. 8 E., a mile west of Parma station, has the following section:

#### *Section of Parma Land Company's well.*

	Thick- ness.	Depth.
	<i>Feet.</i>	<i>Feet.</i>
Recent:		
Soil.....	3	3
Coarse gravel.....	32	35
Fine gravel.....	5	40
Sand.....	10	50
Alamosa formation:		
Blue clay.....	20	70
Sand.....	2	72
Clay.....	73	145
Fine sand (first flow, weak).....	3	148
Clay.....	17	165
Sand.....	1	166
Clay.....	8	174
Coarse sand and gravel.....	4	178
Clay.....	8	186
Gravel.....	2	188
Clay.....	8	196
Sand (flow).....	1	197
Clay.....	23	220
Sand (small flow).....	1	221
Clay.....	30	251
Sand.....	1	252
Clay.....	16	268
Sand (small flow).....	1	269
Clay.....	31	300
Sand and clay.....	4	304
Clay.....	18	322
Sand (fair flow).....	3	325
Clay.....	68	393
Sand (fair flow).....	2	395
Clay.....	26	421
Sand (good flow).....	4	425
Clay, with some dry sand.....	47	472
Sand (heavy flow).....	4	476

This well is 6 inches in diameter and the flow rises about  $1\frac{1}{2}$  inches above the casing.

A well in the northeast corner of sec. 34, on the same ranch and in the same township as the well just described, obtained flows at depths of 140, 225, 275, and 324 feet.

A well at the residence of J. B. Outcault, in the southwest corner of the SE.  $\frac{1}{4}$  sec. 7, T. 38 N., R. 9 E., has flows at 180, 225, 250, 280, and 300 feet.

A well in the northwest corner of sec. 17, one-half mile due east of the Outcault well, struck big flows also at 400 and 550 feet. All told, this well is reported to have had about ten different flows. When new it had a jet 8 inches high, which is now reduced to  $2\frac{1}{2}$  inches.

At H. H. Johansen's ranch, in the NW.  $\frac{1}{4}$  SW.  $\frac{1}{4}$  sec. 24, T. 38 N., R. 9 E., there are two wells with good flows. The larger well, in the reservoir south of the house, is 813 feet deep and is cased throughout. The diameter is 3 inches and the flow rises 4 inches over the casing, indicating a flow of more than 100 gallons a minute. Flows were struck at 250, 500, 600, 760, and 813 feet. At the bottom rock was struck which could not be penetrated in half a day's drilling.

MONTE VISTA AND VICINITY.

A plat of the town of Monte Vista is shown in figure 8. The wells in Monte Vista are more closely crowded than in any other town in the valley, there being 225 in the town and the immediate environs. These are for the most part 2-inch wells, ranging in depth from 115 to 300 feet. Many wells originally sunk to the first flow at 110 feet have been sunk deeper to secure a better flow. At first, here as elsewhere in the valley, wells were cased into the first bed of clay a short distance. Through the caving in of numbers of these wells, there has been such an interchange and mingling of water between the different flows that toward the center of the town, in the region of greatest crowding of the wells, there has resulted a uniformity of flow and a uniformity of temperature as well. In this territory wells yield a flow of about 2 gallons per minute, and have a temperature of 49°, whether the well be 130 or 300 feet deep. Around the borders of the town, particularly at the eastern border, wells have normal flows and temperatures.

The largest well in Monte Vista is that at the Monte Vista Milling Company's plant, sunk in 1897. This well is 302 feet deep. It is cased for 106 feet with 6-inch casing, for 160 feet with  $4\frac{1}{2}$ -inch casing, and for 302 feet with 3-inch casing. A section of the well is as follows:

*Section of Monte Vista Milling Company's well.*

	Thick- ness.	Depth.
Recent:	<i>Feet.</i>	<i>Feet.</i>
Soil and gravelly loam.....	10	10
Gravel and sand.....	50	60
Alamosa formation:		
Clay.....	40	100
Sand (first flow).....	9	109
Sand and gravel, with various flows.....	193	302
Coarse gravel below (strong flow).		

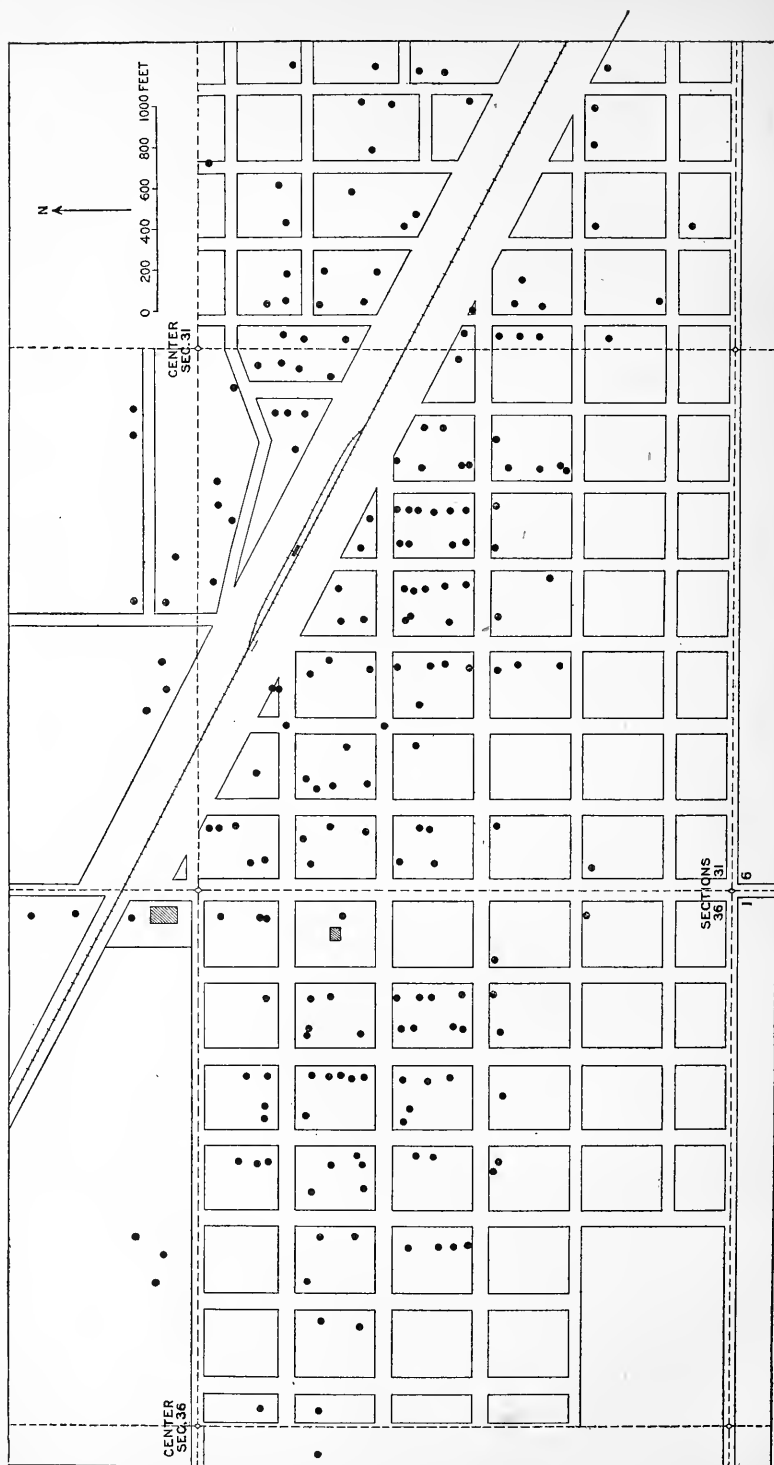

FIGURE 8.—Plat of Monte Vista, showing location of wells.

The well has a pressure of about 5 pounds and a temperature of 49° and flows 400 gallons a minute. An analysis of the water will be found in the table of analyses on page 112.

A section reported as typical for the wells in town is as follows:

*Typical section of wells in Monte Vista.*

	Thick- ness.	Depth.
	<i>Feet.</i>	<i>Feet.</i>
Recent: Soil and gravel.....	50	50
Alamosa formation:		
Clay.....	1	51
Quicksand.....	10	61
Blue clay.....	50	111
Dark sand (first flow).....	9	120
Blue clay.....	8	128
Dark sand (second flow).....	6	134
Blue clay.....	10	144
Black sand (third flow).....	4	148
Blue clay.....	10	158
Black sand (fourth flow).....	3	161
Yellow clay.....	14	175
Yellow sand (fifth flow).....	2	177
Yellow clay.....	23	197
Yellow sand (sixth flow).....	4	201
Yellow clay, with water-bearing beds of sand 2 feet thick at intervals of 10 to 20 feet.	99	300
Boulders below.		

All wells on the east side of town show more clay and less sand and gravel. The head of the first well sunk in Monte Vista is reported to have been 12 to 14 feet. By 1889, according to Professor Carpenter, it had fallen to 7 feet. In 1890, when the number of wells in Monte Vista was 88, it had fallen to 4 feet. In 1904 some of the deeper wells in town still had a head of 7 feet, and the mill well, as noted, has a head of about 11 feet.

Four miles south of Monte Vista, in the valley of Rock Creek; the wells are very close together. The valley of Rock Creek is largely given over to meadows of native hay, and the wells are designed to irrigate the higher portions of these meadows out of the reach of the ditch water. With few exceptions these wells are 2 inches in diameter, as are also the wells in the town of Monte Vista. North and northeast of Monte Vista, across the Rio Grande, in T. 39 N., R. 8 E., practically every quarter section has a 2-inch well for domestic use. This township is well supplied with ditch water and no wells have been bored for irrigation exclusively. The wells in the Monte Vista district, outside of the town itself, all have excellent flows, ranging from 6 or 8 gallons up to 30 gallons a minute.

**CENTER AND VICINITY.**

The village of Center is situated in the midst of the grain belt of the valley, in a region well supplied with ditch water, and the wells are almost exclusively bored for domestic purposes. They are ordinarily 2 inches in diameter, and a fine flow is reached at about 200 to

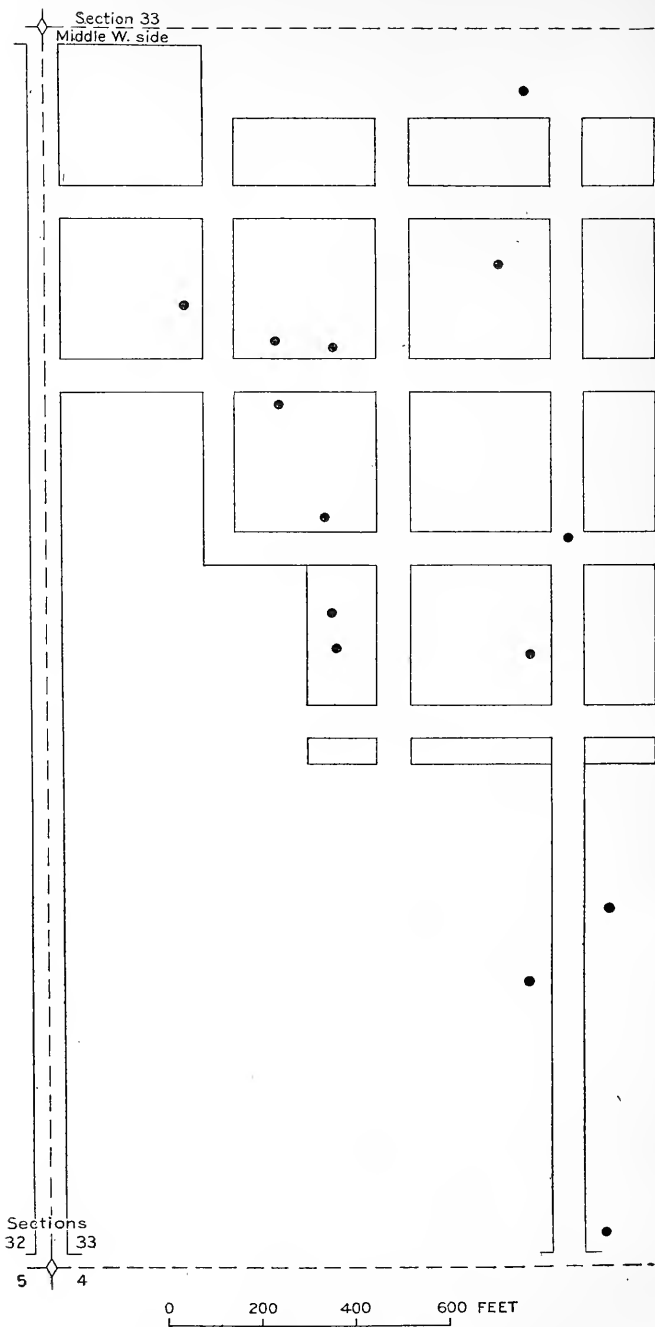

FIGURE 9.—Plat of Center, showing location of wells.



225 feet. The plat (fig. 9) shows the number and location of the wells in the village. The following section is given as characteristic for wells in the immediate vicinity of the village:

*Characteristic section of wells in vicinity of Center.*

	Thick- ness.	Depth.
	<i>Feet.</i>	<i>Feet.</i>
Recent: Soil and gravel.....	60	60
Alamosa formation:		
Clay and sand.....	95	155
Sand (small flow, with some sulphur).....	1	156
Clay.....	10	166
Sand (second flow).....	2	168
Clay.....	12	180
Sand (third flow).....	4	184
Clay.....	12	196
Sand (fourth flow).....	4	200

These flows farther east are found at somewhat greater depths, averaging 10 feet deeper to the mile.

A well in the SE.  $\frac{1}{4}$  sec. 30, T. 40 N., R. 8 E., 5 miles west of south of Center, near the margin of the flowing-well area, is 464 feet deep. The first 200 feet was sand and gravel, with a little clay at the bottom, beneath which was obtained the first flow. Thence to the bottom of the well the formation was sand and gravel with some very thin beds of clay at intervals, but no further flow was found.

**LOCKETT AND VICINITY.**

The well on the John D. Hess place, in the southwest corner of the NW.  $\frac{1}{4}$  sec. 26, T. 41 N., R. 9 E., is reported to have the following section:

*Section of Hess well.*

	Thick- ness.	Depth.
	<i>Feet.</i>	<i>Feet.</i>
Recent: Surface soil and gravel.....	100	100
Alamosa formation:		
Blue clay.....	120	220
Blue clay with streaks of sand.....	160	380
Sand.....	1	381
Light-blue clay.....	80	461
Sand (flow with 4-inch jet).....	2	463
Streaks of clay and sand.....	94	557
Light-blue clay.....	150	707
Sand (flow with 7-inch jet).....	3	710
Light-blue clay.....	58	768
Sand (small flow).....	1	769

The well has a diameter of 3 inches and is cased for 478 feet. The flow is estimated at 135 gallons a minute.

Two miles west of south of the Hess well, in the NE.  $\frac{1}{4}$  sec. 3, T. 41 N., R. 9 E., on H. J. Johnston's place, a well 800 feet deep has the following section:

*Section of Johnston well.*

	Thick- ness.	Depth.
	<i>Feet.</i>	<i>Feet.</i>
Recent: Surface gravel and sand.....	70	7
Alamosa formation:		
Blue clay.....	390	460
Sand (first flow).....	2	462
Blue clay, with streaks of sand (flows every 15 to 30 feet).....	138	600
Sand (big flow).....	10	610
Clay, with a few small streaks of sand (some small flows).....	190	800
Coarse gravel (good flow).....	5	805

The temperature of this well is 63°. The flow is about 150 gallons a minute. The water is caught in a reservoir and used for irrigation.

**VETERAN NEIGHBORHOOD.**

The territory about Veteran schoolhouse, between Veteran and Carnero post-office, is one in which ditch water is likely to fail in a dry year, and this has led to the extensive development of artesian wells. This fact is brought out on the map by the close alignment of the wells along the west side of the farms. The strongest flows in the valley, considering the depth, are to be found in this neighborhood.

One of the largest wells is the Espinosa well in the NW.  $\frac{1}{4}$  sec. 7, T. 42 N., R. 8 E. This well is 3 inches in diameter, 265 feet deep, and cased to the bottom. It throws a jet 25 inches above the top of the casing, equivalent to a flow of over 250 gallons a minute. In 1891 it had a jet 33 $\frac{3}{4}$  inches high, as recorded by Professor Carpenter, who reports that it is said to have had originally a jet 41 inches high. The temperature of this well is 54°. A view of the well is shown in Plate XI, A.

A half mile north, on the Navin ranch, in the southwest corner of sec. 1, T. 42 N., R. 8 E., two 3-inch wells, 383 feet deep, and cased for 83 feet, have jets 10 and 27 inches high, the well with the higher jet having been recently put down. The pressure of the older well as shown by gage indicates a head of 24 feet. The temperature is 55°. The combined flow of the two wells is very nearly 1 second-foot. The first flow was struck at 60 feet, the second at 120, and the third at 335 feet. A view of the newer well is shown in Plate XI, B.

Two miles northeast of Veteran schoolhouse, in the southwest corner of the SE.  $\frac{1}{4}$  sec. 31, T. 43 N., R. 8 E., the Woodhouse well, 2 inches in diameter, has a jet of 13 inches. In this well a species of algæ had grown in such a manner as to constrict the opening and cause the water to jet to a height of 4 feet.

Practically all the wells in this region have excellent flows, but up the rise toward Carnero post-office the flows are smaller and smaller to the limit of the flowing wells.



A. ESPINOSA WELL, BORED IN 1888.



B. NAVIN WELL, BORED IN 1903.

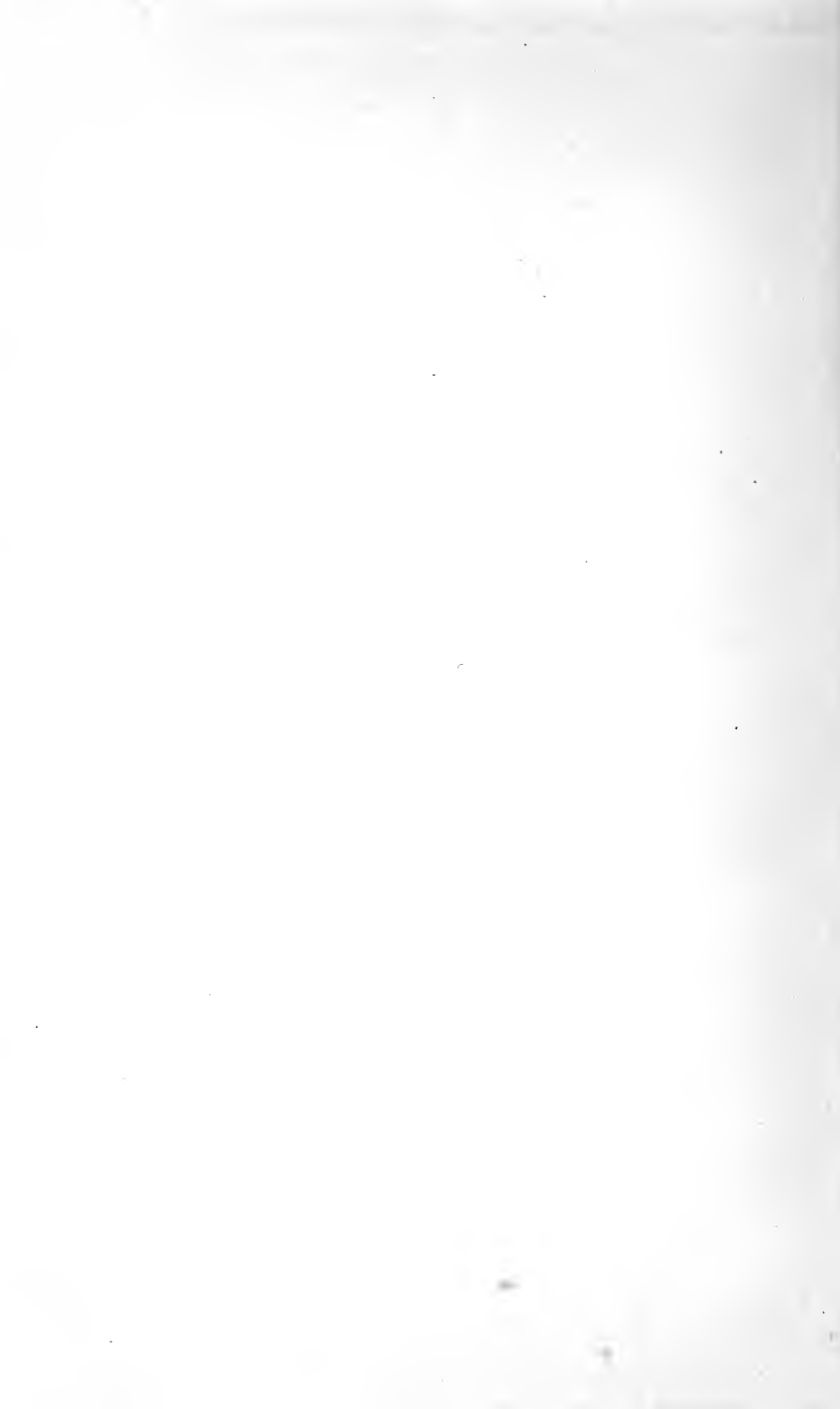

SWEDE CORNERS AND VICINITY.

Over a small area in the vicinity of Swede Corners the wells have an unduly high temperature, out of all proportion to their depth. In four wells at Swede Corners, 100 to 159 feet deep, the temperatures range from 56° to 61°. The high temperatures extend 2 miles southward, and in the northwest corner of sec. 19, T. 43 N., R. 8 E., a well 220 feet deep has a temperature of 58½°. A quarter mile south the well temperature drops to 53°, and a quarter mile southwest of that it is 45°, which is normal in the valley for a well 100 feet deep. One-half mile northeast of the Corners the temperature is 58° and 54°, but a mile and a half northeast it drops to 45° for a well 126 feet deep. Due eastward the temperatures resume the normal at about the same rate. No reason is apparent for these excessive temperatures except the probability of more recent uncooled lavas at no great distance below. Igneous rocks project above the valley slope 2 miles west and also 3 miles north of the Corners. It seems probable that there is in this vicinity an intrusive sheet of lava of small extent a short distance below the surface, the heat radiating from which raises the temperatures in the affected area.

A 3-inch well in the NW. ¼ SW. ¼ sec. 7, T. 43 N., R. 8 E., is reported to have this section:

*Section of well south of Swede Corners.*

	Thick- ness.	Depth.
	<i>Feet.</i>	<i>Feet.</i>
Recent: Gravel.....	10	10
Alamosa formation:		
White clay.....	70	80
Blue clay.....	32	112
Sand (first flow).....	1	113
Blue clay.....	34	147
Sand and gravel (strong flow).....	9	156

The well has a flow of about 130 gallons per minute. The temperature is 61°.

In the northwest corner of the SE. ¼ sec. 6, half a mile northeast of the Corners, a well is reported with this section:

*Section of well northeast of Swede Corners.*

	Thick- ness.	Depth.
	<i>Ft. in.</i>	<i>Feet.</i>
Recent: Soil and gravel.....	12	12
Alamosa formation:		
Clay.....	110	122
Sand (first flow).....	1	123
Clay.....	37	160
Sand (second flow).....	1	161
Clay.....	19	180
Gravel (third flow).....	9	189
Hard layer (fourth flow).....	1	189

The well is 2 inches in diameter and the flow rises 3 inches above the casing. The temperature is 58°.

In lot 1, in the northeast corner of the same section as the last-described well, there is a 3-inch well, whose water has a pronounced chalybeate taste and leaves a yellowish rusty deposit on the sides of the stream running away from the well.

#### WARNER NEIGHBORHOOD.

In the neighborhood of Warner schoolhouse the supply of water from the irrigation canals has been inadequate for several seasons, and the dependence is almost altogether on artesian water. Most of the wells sunk for irrigation purposes are 3 inches in diameter, but recently several 4, 5, and 6 inch wells have been put down for that purpose. These secure good flows at an average depth of about 200 feet. The following section is given by local well drillers as typical of the region:

*Section of well near Warner schoolhouse.*

	Thick- ness.	Depth.
Recent:	<i>Feet.</i>	<i>Feet.</i>
Soil and alluvium.....	5	5
Wash gravel and sand.....	75	80
Alamosa formation:		
Clay.....	100	180
Sand, gravel, and clay (several small flows and one strong one).....	40	220

#### MOFFAT AND VICINITY.

All the wells in the low ground about Moffat and extending north toward Mirage station have good flows ranging from 50 to 100 gallons or more a minute. The sketch plan of the village of Moffat (fig. 10) shows the location and number of the wells in that place.

The Denver and Rio Grande Railroad well at Moffat is one of the deepest wells in the valley. No geologic record of the well is available. It is 1,045 feet deep. The bore is 8 inches for 300 feet, and 3 inches from that depth to the bottom. The first flow was struck at 365 feet, the fourth and largest flow at 880 feet, and the sixth flow at a depth somewhat greater than 1,000 feet. The large flow was cased off, so that only the lower flow is now running. This has a head of over 30 feet and discharges about 207 gallons a minute into the water tank 27 feet above the ground. Small pecten-like shells an inch in diameter are reported at a depth of 900 feet. An analysis of water from this well will be found in the table of analyses on page 112.

Along the course of the Rito Alto from Moffat to the flowing-well limit there are a number of good wells, principally on the Shellabarger, Wales, and Frazee ranches. A 2-inch well in the northeast corner of sec. 4, 2 miles northeast of Moffat, is 300 feet deep, cased for 200 feet. It has a flow of about 70 gallons a minute. The well has a head of over 32 feet. In sec. 34, half a mile northeast of the last-mentioned well, a 3-inch well, 770 feet deep and cased to 660

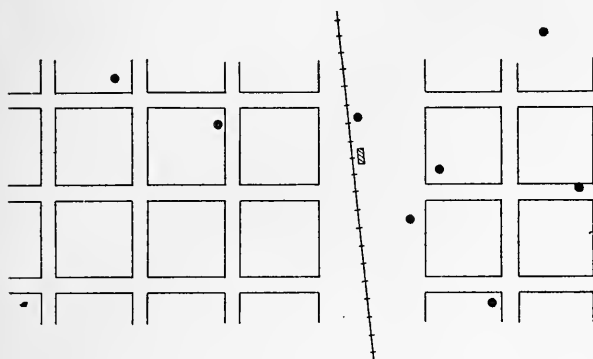

FIGURE 10.—Plat of Moffat, showing location of wells.

feet, has a good flow. A 3-inch well a short distance northeast, with a depth of 308 feet, has a flow which rises 3 inches over the casing.

At A. Shellabarger's house there is a well 665 feet deep, which is

cased 3 inches in diameter to a depth of 300 feet and 2 inches in diameter to a depth of 616 feet. Much difficulty was experienced in sinking this well, owing to the cobblestones that lay scattered all the way through the sand and clay. It was necessary to attach a perforated pointed steel shoe to the bottom of the casing in order to force it down. A section of the well is as follows:

*Section of Shellabarger well.*

	Thick- ness.	Depth.
	<i>Feet.</i>	<i>Feet.</i>
Clay and sand with cobblestones.....	300	300
White clay.....	1	301
Sand (good flow).....	2	303
Clay.....	37	340
Sand (flow).....	2	342
Sand and clay (flows about every 20 feet).....	274	616
Clay.....	24	640
Gravel below (strong flow).....		

The water has a temperature of 61°. A 2-inch well near by, which draws from the flow at 300 feet, now yields 8 or 10 gallons per minute with a head of 4 feet. Originally the head was 11 feet and the flow about 30 gallons a minute. The temperature is 51°.

At the Frazee house, near the center of sec. 14, a well 367 feet deep has a temperature of 53°. Flows were struck at 220, 260, and 335 feet in depth, the first two being light.

## MIRAGE AND VICINITY.

Mirage is situated just on the limit of the flowing-well area, and a number of wells which once flowed now lack a few feet of rising to the surface. South and west of the town the wells get good flows. A 3-inch well on the Davidson ranch, in the SE.  $\frac{1}{4}$  sec. 4, a half mile south of the post-office, has a flow of 25 gallons a minute. Flows were struck at 120, 155, 185, and 213 feet in depth.

Another well on the Davidson ranch, in the NE.  $\frac{1}{4}$  sec. 3, three-quarters of a mile east of the post-office, is 613 feet deep, cased to 400 feet. No water was struck that would flow. At 613 feet water rose within 6 inches of the surface. Solid rock, believed to be sandstone by the driller, was found at 613 feet.

A well near the middle of the south side of the SW.  $\frac{1}{4}$  sec. 34 was originally a flowing well, but the water now stands 6 feet from the top.

The well at Tobler's, in the northeast corner of the SE.  $\frac{1}{4}$  sec. 33, is 218 feet deep. When sunk six years ago it flowed, but the water is now reported to stand 16 feet from the surface. Other attempts to get water at Tobler's show sand and clay to a depth of 200 feet, where there is a layer of hardpan, thence gravel to 500 feet, below which there is 40 feet of clay.

A well near the northeast corner of sec. 33 is 435 feet deep. A flow was struck at 308 feet which yielded one-third gallon a minute for some time, but the flow failed and the water now stands 6 feet from the surface.

A well in the northeast corner of the SE.  $\frac{1}{4}$  sec. 30 struck water at 200 feet in solid gravel. In the northwest corner of the NE.  $\frac{1}{4}$  sec. 30 a well over 600 feet deep is 6 inches in diameter for 100 feet, thence 4 inches for 400 feet, and 3 inches to the bottom. This well flowed a little originally but now lacks a few feet of rising to the surface.

The fluctuations in the head of these wells are not to be considered as changes in the artesian pressure of the region but rather as local manifestations due to defects in the casing, caving in, or something of that sort. The absence of any regularity in the depth at which the flows are obtained is a result of the different conditions of deposition of the sand and clay beds in the narrowed area of the valley in this vicinity, the sedimentation here partaking more of the character of the irregular deposition in alluvial fans and cones. This feature is likely to be more marked farther north up this arm of the valley.

## SAN ISABEL AND VICINITY.

In the vicinity of San Isabel post-office there are a number of good wells. A 3-inch well in the NW.  $\frac{1}{4}$  NW.  $\frac{1}{4}$  sec. 15, T. 43 N., R. 10 E., has a depth of 380 feet and a flow of 55 gallons a minute. The water has a temperature of  $55\frac{1}{2}^{\circ}$ , is clear and tasteless, and yields no gas,



though it is near the northern limit of the Mosca-Hooper area of gas-bearing waters. At the post-office a 3-inch well affords a large flow of water with a temperature of 57°.

In the NW.  $\frac{1}{4}$  sec. 12, a mile northeast of the post-office, a 3-inch well 450 feet deep is cased to 200 feet. It has a head of over 30 feet, and a flow which rises 4 inches over the casing, yielding about 100 gallons a minute. It is situated in a reservoir and is used in irrigation.

In the SE.  $\frac{1}{4}$  NE.  $\frac{1}{4}$  sec. 2, in the same township as the well just described, a 3-inch well 375 feet deep has a temperature of 58° and affords a fair flow of water. A quarter mile south of this well a new 3-inch well 890 feet deep affords a fine flow of water.

On the H. Nash ranch, in the SE.  $\frac{1}{4}$  NE.  $\frac{1}{4}$  sec. 7, T. 43 N., R. 11 E., just north of the Baca grant, a 3-inch well reaches a depth of 865 feet, cased for 520 feet. Three flows were struck, the lowest of which is reported to jet the water 6 inches above the casing, indicating a yield of 125 gallons a minute. A section of this well is as follows:

*Section of Nash well.*

	Thick-	Depth.
	ness.	
	<i>Feet.</i>	<i>Feet.</i>
Recent: Gravel and red sand .....	85	85
Alamosa formation:		
Yellow clay .....	15	100
Red sand .....	30	130
Yellow clay .....	70	200
Red sand .....	70	270
Black sand .....	100	370
Blue clay .....	150	520
Red and white sand (flow, 1-inch jet) .....	85	605
Blue clay .....	100	705
Hard white sand (flow, 3-inch jet) .....	30	735
Blue clay, hard .....	100	835
White sand (flow, 6-inch jet) .....	30	865

The total cost of the well was \$300.

**BACA GRANT.**

The eastern limit of the flowing-well area passes through the Baca grant, taking in a strip on the west side of the grant in which flowing wells can be got, widening from 3 miles on the north to over 5 miles on the south. The ranch is given over to stock raising, with some native-hay land; so most of the wells have been sunk to obtain stock water. Several deep wells that failed to get water are described under the head of nonflowing wells in the vicinity of Crestone (p. 100).

The well at the sheds is 3 inches in diameter and 481 feet deep. It flows 8 to 10 gallons a minute and has a temperature of 62°. The well by the lake in the southwestern portion of the grant is 3 inches in diameter, with a flow of 25 gallons a minute. The water is very slightly tinted and there is a good flow of gas. At the South Camp the 3-inch well has a temperature of 47° and a flow of 8 gallons a minute.

## MEDANO RANCH.

On the Medano ranch there are twenty-seven 2 and 3 inch wells ranging from 200 to 600 feet in depth. The flows in general are good. Those on the west side of the ranch usually have more or less gas, and the water shows a slight brownish tint, in common with the waters of the Mosca-Hooper district.

One of these, in the SE.  $\frac{1}{4}$  sec. 7, T. 40 N., R. 12 E., known as the Baker well, is 476 feet deep. It is cased for some distance with 2-inch pipe, and to the bottom with 1 $\frac{1}{4}$ -inch pipe. Small flows were struck at 121, 165, and 476 feet. The well went through coarse sand much the greater part of the distance, and there was but a small amount of clay.

## CALKINS RANCH.

On Mrs. A. M. Calkins's ranch near the center of sec. 1, T. 38 N., R. 12 E., of three wells 217 to 228 feet deep, two struck flowing water and one, the easternmost, failed to get a flow. In the two wells water was struck at 160 feet and lacked 2 feet of reaching the surface. The flow was struck at 228 feet.

A well on the same ranch in the SE.  $\frac{1}{4}$  sec. 2, T. 38 N., R. 12 E., gave the following record:

*Section of Calkins well.*

	Thick- ness.	Depth.
	<i>Feet.</i>	<i>Feet.</i>
Recent: Gravel and sand.....	50	50
Alamosa formation:		
Clay.....	10	60
Black sand (water rose just to surface).....	70	130
Clay.....	50	180
Black sand (second flow).....	60	240
Clay.....	50	290
Black sand (strong flow).....	10	300

A 2-inch well 195 feet deep in sec. 16, T. 38 N., R. 12 E., bored in 1902, is reported to have thrown a jet 12 inches above the casing when new and not to have failed any since. A section of the well is reported as follows:

*Section of well in sec. 16, T. 38 N., R. 12 E.*

	Thick- ness.	Depth.
	<i>Feet.</i>	<i>Feet.</i>
Recent: Gravel (cased).....	95	95
Alamosa formation:		
Blue clay.....	100	195
Gravel size of pigeon's egg (strong flow).....	1	196

## CENTRAL OR MOSCA-HOOPER REGION.

## OCCURRENCE OF GAS AND COLORED WATER.

Lying in the trough of the valley and stretching from a point 4 miles northeast of Alamosa within 3 miles of Moffat, with a length of 30 miles and an average width of 8 miles, is an area in which gas is mingled with the waters of the deeper wells. Coinciding with this area, but extending 3 or 4 miles farther west, is a region in which the water of the deeper wells is colored. This color varies from the lightest tints of brown or brownish yellow to a decided brownish color, like that of swamp water or water that has collected in rotten wood. Both areas are shown on the map accompanying this report (Pl. I). This region of tinted and gas-bearing water is generally known as the Mosca-Hooper district.

In explanation of this occurrence of gas and tinted water there is to be noted the significant position of the area in the trough of the valley, with which it so strikingly corresponds in outline. Just as this is now the lowest portion of the valley, it probably was so in the later stages of deposition of the Alamosa formation. The occurrence, particularly in this district, of wood, bark, peaty moss, and seeds has already been noted. The high content of alkalies in the tinted waters is shown in the table of analyses on page 112. That this is not a separate basin, and that the same aquifers which farther west yield the usual pure water of the valley here yield the tinted alkali and gas-bearing water, is proved by the continuity of the aquifers, the evidence of which has already been shown (p. 44). Consideration of these facts leads to the conclusion that there were arid periods during the deposition of the water-bearing sands and clays of the Alamosa formation, when the water of the lake shrank to a small shallow area in the trough of the valley, and that this area of more or less alkaline water afforded a growth of vegetation, in particular of mosslike plants. Later, when the deposition of the series was complete, these interbedded alkaline and peaty sands and clays became water bearing. As water was drawn from the area pure water from the outside took its place and in turn dissolved the alkalies and took up the peaty infusion. Thus in time, with the continual draft upon the waters of the area, they must tend to become fresher and less highly colored and eventually, in the remote future, to become like the other water of the valley. The extension of the colored-water area beyond the gas-bearing area, west of Mosca and Hooper, admits of an interesting speculation. It seems reasonable that the heavy drain upon the water-bearing series in the region of closely crowded wells west of Mosca and Hooper has caused a movement of the waters out from the Mosca-Hooper district toward the region of heavy drain, and that this movement carried the colored water beyond its

original bounds. Just why there was not a similar migration of the gas is not so clear, though it is true that the gas occupying the local irregularities in the upper surface of the aquifers would not be so subject to lateral movement as the water. Furthermore, it is probable that some of the gas is stored in lenses of sand inclosed in the clay beds and not laterally connected with the aquifers. In such a situation it would not be subject to movement like that of the water.

The presence of gas has led to some prospecting for oil. The log of the deepest well sunk by the Chicago and San Luis Oil Company,  $4\frac{1}{2}$  miles due east of Mosca, is given on page 43. Oil scum on the water and oil on the drill rope are reported from this well, but no flow of oil was struck, and prospecting is at a standstill. In general it is not to be expected that oil and gas will be struck in an artesian basin; yet the Florence (Colorado) oil field is an instance of such a relation. The oil there arises from carbonaceous shales and is stored in lenticular bodies of sandstone inclosed on all sides by shale. From the sections and discussions in the preceding pages it is clear that the Alamosa formation is made up of a series of persistent clay and sand beds, so that the occurrence of lenticular beds of sand near the center of the valley is not to be expected. It may be, however, that in the local heavy beds of clay reported in the region there are sand lenses; and the possibility of gas occurring in these has already been mentioned. It may safely be predicted, however, that no considerable quantity of oil will ever be found in the Alamosa formation, for the beds of that formation are but slightly carbonaceous and the quantity of gas already discovered is as great a volume of hydrocarbons as the carbonaceous content of the formation could reasonably be expected to furnish. Further, the underlying Santa Fe formation (gravel beds interbedded with lava flows) offers very little prospect for oil below the Alamosa formation. The chance in the San Luis Valley of striking any oil-bearing beds of greater age than these at any depth, however great, is exceedingly remote.

#### MOSCA AND VICINITY.

No accurate log exists of any deep well in the immediate vicinity of Mosca, but the geologic section of the "oil well," 1,283 feet deep,  $4\frac{1}{2}$  miles east of Mosca, has been given on page 43. In the village itself there are 17 wells, the location of which is shown on the town plat (fig. 11).

The town well in Mosca is 400 feet deep. The first flow, at 160 feet, just comes to the surface. This flow is clear. Other flows, every 15 to 30 feet down to a depth of 400 feet, are colored with various tints of light brown. The chemical composition of the water is given in the table of analyses, page 112.

A 5-inch well near the schoolhouse in Mosca is 500 feet deep. The temperature is 66° and the flow is about 50 gallons a minute. The water is of a decided brownish color and has a slight taste, neither acid nor salty, yet repellent.

The Mosca Milling and Elevator Company's well is 4 inches in diameter and 600 feet deep. The first flow was struck at 200 feet and other flows about every 50 feet down to the bottom of the well. The well furnishes a large flow of water, which has a very slight brownish tint and a very small amount of gas. The tempera-

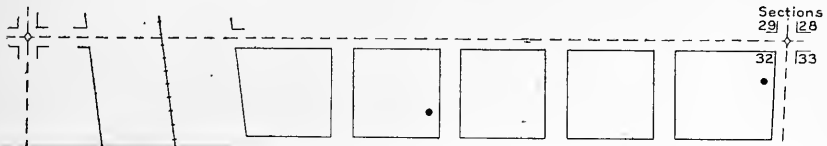

NOTE.

Figures 11 and 12 should be transposed. The plat on page 83 is a plat of Hooper and that on page 86 a plat of Mosca.  
Water-Supply Paper 240.

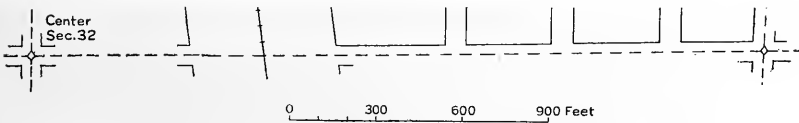

FIGURE 11.—Plat of Mosca, showing location of wells.

ture is 69°. An analysis of the water will be found in the table of analyses, page 112.

A well in the SE.  $\frac{1}{4}$  sec. 16, a mile south of Mosca, is 385 feet deep. The water has a temperature of 60°, a light-brownish tint, and a slight taste of sulphur. This is the second flow, but the first flow, at 80 feet, is reported to be good clear water.

At Peter Andersen's, in the NW.  $\frac{1}{4}$  SW.  $\frac{1}{4}$  sec. 26, T. 39 N., R. 10 E., the well is cased 2 inches in diameter to a depth of 340 feet and 1  $\frac{1}{4}$

inches in diameter to a depth of 500 feet, the first flow, at 200 feet, thus being cased off. The upper flow, from a depth of 340 feet, has a temperature of 62° and the lower flow, from a depth of 500 feet, a temperature of 63°. There is probably a greater difference than this in the real temperatures of the flows, but flowing alongside each other to the surface they tend to come to an average. The upper flow has a perceptible color and a peculiar taste, such as one would expect of water standing in a hollow stump. The lower flow has a pronounced taste and color, and there is perceptible a very small amount of gas. The upper flow yields about 1 gallon and the lower about 4 gallons a minute. An analysis of the water from the lower flow is given in the table of analyses on page 112.

A 3-inch well in the NE.  $\frac{1}{4}$  sec. 27, one-fourth mile northwest of Andersen's well, of unknown depth, has a temperature of 66°. The water from this well is very dark and kills all the vegetation along the overflow from the well in a strip 10 to 15 feet wide. Over this area white crusts of alkali have formed around the drying edges of the stream.

A mile south of Andersen's well, in the northwest corner of the SW.  $\frac{1}{4}$  sec. 35, a 2-inch well, 500 feet deep, which has now ceased to flow, furnished water for the analysis by Dr. W. P. Headden, which is given in the table of analyses on page 112.

In the NW.  $\frac{1}{4}$  NW.  $\frac{1}{4}$  sec. 8, T. 38 N., R. 11 E., there is a 3-inch well 800 feet deep which flows 3 inches over the casing, indicating a flow of about 90 gallons a minute. The temperature is 71°. There is a slight flow of gas. The water has a light-yellowish tint and a slight taste of sulphur. Its chemical composition is indicated in the table of analyses, page 112.

Several miles west of Mosca, on the J. M. Chritton ranch, the following section occurs, according to Professor Carpenter:

*Section of Chritton well.*

	Thick- ness.	Depth.
	<i>Feet.</i>	<i>Feet.</i>
Recent:		
Dark sandy loam .....	7	7
Coarse sand and gravel.....	13	20
Alamosa formation:		
Fine light-yellow sand.....	22	42
Yellow impervious clay.....	18	60
Blue clay.....	98	158
Black sand (small flow).....	1	159
Blue clay.....	4	163
Fine black sand (fine flow).....	3	166
Blue clay.....	45	211
Fine black sand (flow).....	12	223
Blue clay.....	53	276
Black sand (strong flow).....		

On the Watson ranch, 5 miles northwest of Mosca, there are two 3-inch wells which are both 712 feet deep and are cased to a depth of 200 feet. One of them is in the SW.  $\frac{1}{4}$  sec. 35, and the other is in the SE.  $\frac{1}{4}$  sec. 34, T. 40 N., R. 9 E. The flow of these wells has a temperature of 63° and forms a jet 5½ inches high, indicating a flow of approximately 120 gallons a minute. A section of this well is reported as follows:

*Section of Watson well.*

	Thick- ness.	Depth.
	<i>Feet.</i>	<i>Feet.</i>
Recent: Gravel and sand.....	60	60
Alamosa formation:		
Yellow clay.....	4	64
Gray sand.....	16	80
Blue clay.....	30	110
Black sand (water, no flow).....	3	113
Blue clay.....	87	200
Sand (first flow, small).....	2	202
Blue clay.....	38	240
Sand (second flow).....	2	242
Blue clay.....	58	300
Sand (third flow).....	2	302
Clay with sand beds (numerous flows).....	333	635
Sand (main flow).....	12	647
Clay with sand beds (small flows).....	65	712

**HOOPER AND VICINITY.**

There are 23 wells shown on the Hooper town plat (fig. 12). Most of these flow through the drill rods, consisting of 1-inch pipes, which are allowed to remain in the wells in order to lessen the liability to cave in that is shown by wells in this vicinity.

The Garrison Mill and Elevator Company's well was sunk in August, 1897, has a diameter of 4½ inches, is cased to the bottom, and flows 70 gallons a minute. The temperature is 69°. The water has a pronounced taste of soda and a slight brownish tint, with a very small flow of gas. An analysis of the water will be found in the table of analyses on page 112. The log is as follows:

*Log of Garrison Mill and Elevator Company well.*

	Thick- ness.	Depth.
	<i>Feet.</i>	<i>Feet.</i>
Recent: Surface gravel and sand .....	90	90
Alamosa formation:		
Blue clay.....	15	105
Black sand (no flow).....	5	110
Blue clay.....	90	200
Fine sand (first flow, small).....	5	205
Blue clay with 2-foot beds of sand and flows every 50 feet (various flows).....	445	650
Blue clay, in strata 15-30 feet thick, with interstratified sand beds 12 feet thick (various flows).....	90	740

The Denver and Rio Grande Railroad well, situated 250 feet south-east of that described above, has the following record:

*Log of Denver and Rio Grande Railroad well at Hooper.*

	Thick-ness.	Depth.
	Feet.	Feet.
Recent:		
Soil.....	3	3
Gravel.....	10	13
Alamosa formation:		
Sand.....	52	65
Blue clay.....	143	208
Blue clay with sand strata.....	124	332
Sand (small flow).....	1	333
Clay and sand (various flows).....	251	584
Blue clay.....	30	614
Sand below (heavy flow).....		

The diameter of the well is 4 inches. The flow originally had a head 27 feet above the top of the ground and the well had a flow of

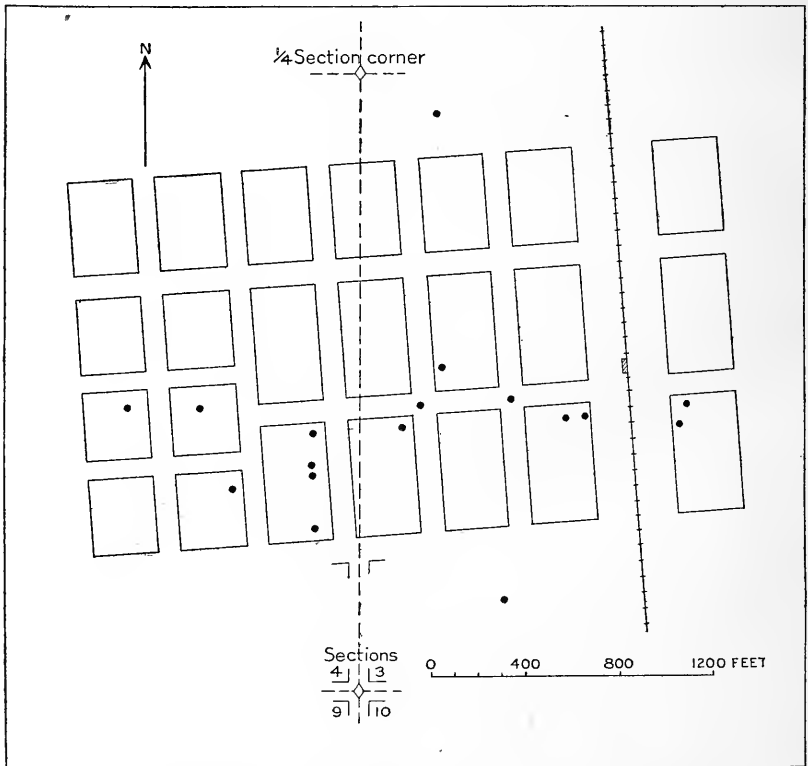

FIGURE 12.—Plat of Hooper, showing location of wells.

50 gallons a minute. The water has a decided brownish tint and is without gas. An analysis of the water is given in the table of analyses on page 112.



The town well, situated in the intersection of Fourth avenue and Main street, is about 300 feet deep. It is cased for a short distance with 3-inch casing, and inside this is a 2-inch casing reaching to the bottom of the well. The flow is approximately 1 gallon a minute but was originally about 4 gallons. The temperature is 53°. The water is clear, with a slight taste of sulphur. The sodium carbonate in this well, as determined by the electrolytic method, is 103 parts per million.

A well in block 8, in the northeast corner of the town, is 1 inch in diameter and 425 feet deep. It has a head somewhat more than 14 feet. The temperature is 54° and the water clear.

A 2-inch well in the northwest corner of sec. 6, T. 42 N., R. 10 E., has a temperature of 65° and flows 2½ inches above the casing, indicating a volume of 35 gallons a minute. The water has a decided brownish tint. An analysis of this water, published by the United States Department of Agriculture,<sup>a</sup> is given in the table of analyses on page 112.

A well one-half mile west of Swede schoolhouse, in the SE. ¼ sec. 19, T. 41 N., R. 10 E., struck flows at the following depths:

	Feet.
First flow.....	220
Second flow (good).....	380
Third flow.....	450
Fourth flow.....	510
Fifth flow.....	550

The well is cased for 112 feet. The flows below 380 feet are now shut off by caved walls. The temperature is 59° and the well has a flow of 15 gallons a minute. The water has a slight brownish tint.

In the corral on the ranch of George W. Clark, in the SE. ¼ NW. ¼ sec. 18, T. 41 N., R. 11 E., there is a 3-inch well 630 feet deep, cased to 360 feet. It has a temperature of 60° and a discharge of about 70 gallons a minute. The water has a faint brownish tint and is highly charged with gas. The well is equipped with a device for separating the gas from the water and storing it, a reproduction in miniature of a municipal gas-storage tank, which is shown in Plate XII, A. Collected in this way the well affords a sufficient volume of gas for a cook stove and one gas jet. The gas, in common with

<sup>a</sup> Field operations, Bureau of Soils, 1903, p. 1114.

that of the Mosca-Hooper district, has a strong benzine-like odor. The section of the well is as follows:

*Section of Clark gas well.*

Material.	Thick- ness.	Depth.
	<i>Feet.</i>	<i>Feet.</i>
Recent (in part): Sand and gravel.....	185	185
Alamosa formation:		
Clay.....	15	200
Sand (first flow, small).....	50	250
Clay.....	25	275
Sand (second flow).....	10	285
Clay.....	30	315
Sand (flow with gas).....	10	325
Clay and sand (flows with gas every 20 to 30 feet).....	252	577
Clay.....	50	627
Very hard stratum.....	(a)	627
Sand (strong flow of water with gas).....	3	630

<sup>a</sup> 1 inch.

On the Star ranch, in sec. 26, T. 42 N., R. 10 E., there are two 3-inch wells, both of which yield gas. The one at the corral, supposed to be between 400 and 500 feet deep, has a temperature of 48° and flows less than a gallon a minute. The water is of a light-yellow color. The escaping gas forms a frothy foam, which stands 6 inches above the surface of the water and burns with a bright yellow flame. Half a mile southeast of the corral is the other well, bored 3 inches in diameter to a depth of 400 feet and 2 inches in diameter to a depth of 800 feet. The water has a temperature of 70°, a light-brownish tint, and a peculiar saltish taste. The flow of water, mixed with gas, fills the 2-inch horizontal discharge pipe and amounts to 20 or 25 gallons a minute. It is used for stock water. The well affords a considerable volume of gas, which burns with a yellow flame 2 feet high. The amount of gas would apparently be ample to run a heating or cooking stove or several gas jets.

**KINNEY RANCH.**

On the Stephen Kinney ranch there are ten wells, ranging from 500 to 1,018 feet deep, all of which have, for the valley, copious flows of gas though not very good flows of water. Owing to the tendency of 2 and 3 inch wells to become choked up by indrawn chunks of clay, the drill rods were left in all these wells, so that the water now flows through 1-inch pipes. An unusual feature of the geologic structure of this region is the reported preponderance of clay, the scarcity and small size of the sand beds, and the great depths to the flows.

The house well, near the center of sec. 35, T. 43 N., R. 10 E., is cased 2 inches in diameter for 454 feet, shutting off the first flow, a small one with much gas, at 450 feet. The 1-inch casing reaches to

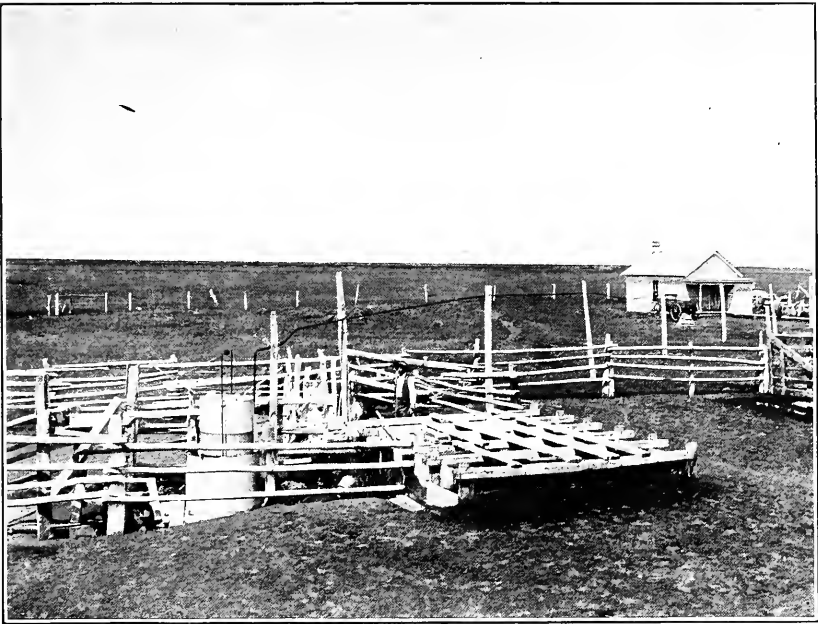

A. CLARK'S GAS WELL AND STORAGE TANK.



B. HUNT SPRINGS, LOOKING EASTWARD ACROSS THE NORTH END OF SAN LUIS VALLEY.



630 feet and the depth of the well is 639 feet. The flow is about 10 gallons a minute, with much gas. The water has a temperature of 63° and a taste and tint similar to the other gas-bearing waters of the Mosca-Hooper district. A short distance from this well another one has been recently sunk with the object of obtaining gas for domestic uses. The diameter is 2 inches and the depth 766 feet. The temperature of the water is 68°. A good flow of gas was obtained, which is collected and stored in a suitable tank.

In the SW.  $\frac{1}{4}$  sec. 3, T. 42 N., R. 10 E., there is a well cased 3 inches to 864 feet and 2 inches to 995 feet. The total depth of the well is 1,018 feet. The well stopped in a black sticky mud, which could not be handled by the hydraulic process of boring. A small flow was found at 600 feet and a better one at 700 feet, but both had so much gas that they choked up the pipes. According to the driller, Mr. Charles Speiser, the gas here caused a geyser-like intermittent flow, which, at intervals of an hour, caused the water to flow to the top of the derrick, 32 feet high. Later the interval lengthened to four or six hours, and mud and water were thrown to a height of 60 and 75 feet. The rise and fall of the column was gradual. White at first with the foam of included gas, the column would afterward become black with indrawn mud and sand. When the foam was ignited at the bottom the flame would run to the top of the column and fire balls would drop down the side and reignite the foam at the bottom, the flame mounting the column again. After a month the well became choked. It was cleaned out and the gas was cased off. Another flow was found at 760 feet, which again threw mud and water over the derrick. After the escape of the gas a soft sandy mud filled with "seeds" was pumped out. The "seeds" floated upon the water and covered it. They were soft and were brownish in color, turning to black in sunlight. This flow was likewise cased off, and but a single weak flow, at 830 feet, was found to the bottom of the well. This well is but 8 miles southeast of the Denver and Rio Grande Railroad well at Moffat, which is nearly of the same depth and which struck such large flows of water.

Another well in the southwest corner of sec. 11, T. 42 N., R. 10 E., is 835 feet deep. No flow at all was noticed in drilling this well, but a small one with considerable gas came in afterward. The flow of water is irregular, sometimes very small, sometimes spouting (mixed with gas) 4 feet over the casing, and again flowing gas only.

#### JACOBS RANCH.

The Jacobs ranch marks the extreme northwestern extent of the gas region. Several wells yield considerable gas, but no use is made of it.

In the NW.  $\frac{1}{4}$  sec. 26, T. 43 N., R. 9 E., a 2-inch well 500 feet deep is cased for 125 feet. It has a flow of 25 gallons a minute. The

water has a temperature of  $58^{\circ}$  and the usual taste of the gas-bearing water, but no color is visible. There is a fair flow of gas.

At the ranch house, in the NE.  $\frac{1}{4}$  sec. 34, the 3-inch well is 404 feet deep and is cased for 224 feet. It flows about 40 gallons a minute. The water has a temperature of  $57^{\circ}$ , a slight taste, and a faint color. It has also a good flow of gas.

The strongest flow of gas on the ranch, however, is found in the NE.  $\frac{1}{4}$  sec. 10, T. 42 N., R. 9 E., in a 3-inch well 650 feet deep, cased for 325 feet. The flow of water is reported to be about 70 gallons per minute.

#### SAN LUIS VILLAGE.

San Luis village lies altogether outside of the artesian area of the valley. Culebra Creek cuts through the lava-capped San Pedro Mesa and east of the mesa, together with the Rito Seco, it has cut out of the Santa Fe formation a parklike valley 3 miles wide and several miles long. Situated on the Rito Seco, just above the point where it joins Culebra Creek at the gap in the mesa, is the village of San Luis, a plat of the older portion of which is shown in figure 13. Within the town limits in the last few years a number of wells have been bored which yield flowing water. In a few other wells the water comes almost to the surface. In two wells of this sort, where the water rises within 6 or 8 inches of the surface, a hole 3 or 4 feet deep has been dug

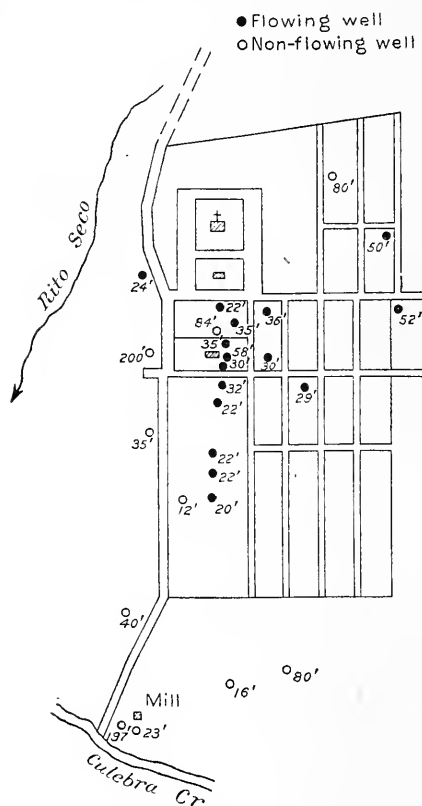

FIGURE 13.—Plat of San Luis, showing location of wells.

about the mouth of the well and the casing cut off low enough to give a flow of a gallon or so per minute. The waste water escapes into the gravel and causes no inconvenience. The distribution of the wells and their depth are shown in figure 13. The flowing wells are bunched about the court-house square but extend a little farther to the south; outside of this area the wells either do not strike water or yield water that does not rise to the surface. In this area of flowing wells there seem to be two flows, one at a depth of about 20

feet and another at 50 to 60 feet. Most of the wells draw from the upper flow. Of those deep enough to reach the lower flow one at least draws from the upper flow. Judging from the small size of the artesian area, its shallowness, and the irregularity of the formations, as seen in the well sections, the flow is probably due to underflow of the Rito Seco, and its localization to irregularity of deposits in some prehistoric channel of that stream. The temperature (in December) ranges from 45° to 47° but bears no relation to the depth of the well, depending rather on the rate of flow of the well; the weaker wells have the lower temperature because the water in its slow rise through the ground has opportunity to cool to surface-soil temperatures.

The court-house well, bored in 1892, is 3 inches in diameter and 58 feet deep, cased all the way. The flow was struck at 25 feet, under a few inches of clay, and the well was continued in gravel to the bottom without increasing the flow. The temperature is 46°.

Doctor Smith made two unsuccessful attempts to find water just west of the court-house, across Main street. The deepest hole gives the following section:

*Section of Smith well.*

	Thick- ness.	Depth.
	<i>Feet.</i>	<i>Feet.</i>
Alluvial clay.....	15	15
Sand.....	5	20
Hard clay.....	1	21
Red sand with streaks of blue sand (no flow).....	179	200

The water sank as fast as it was pumped into the well in drilling. Another well near by, 70 feet deep, also failed to get water. A third well was sunk in the court-house yard and struck a small flow at 20 feet and a better one, yielding 5 gallons a minute, at 59 feet. This is the same flow that the court-house well strikes.

W. S. Parrish bored a third well in the court-house yard, south of the other two. This is only 30 feet deep, but it evidently reaches the same flow as the others; for when it is allowed to flow freely, its orifice being lower than those of the other two, their flow is completely stopped. This difficulty is remedied by reducing the discharge pipe of the Parrish well to one-half inch; then the others are affected but little. The water is piped to Mr. Parrish's house, near the southwest corner of the town.

Five wells in a row along Main street south of the court-house yard are 22 to 32 feet deep and have flows varying from 1 to 5 gallons a minute. The temperature of the shallow ones is 47°. In the blocks immediately east and southeast of the court-house three wells are 30 to 36 feet deep, the flow ranging from 1 to 2 gallons a minute and the temperature from 45° to 47°.

East and west of the schoolhouse and church the wells do not flow, the water lacking from 6 inches to 5 feet of reaching the surface.

South of the village, in the neighborhood of the mill, Mr. Parrish made several attempts to strike flowing water but failed in each attempt, though the elevation is about 20 feet less than that of the court-house yard. The deepest well, 197 feet deep, furnishes this section:

*Log of Parrish's mill well.*

	Thick- ness.	Depth.
	<i>Feet.</i>	<i>Feet.</i>
Soil.....	4	4
Gravel.....	23	27
Quicksand and streaks of clay.....	75	102
Hard sand.....	95	197

The water rose within 3 feet of the surface. Another well was sunk to a depth of 80 feet at a point 300 yards northeast of the mill, in the vicinity of several springs. This showed a section similar to that just given. Above a depth of 40 feet the water rose within 2 feet of the surface, but as boring progressed below that depth the water sank instead of rising.

A well in the bottom, 1 mile southeast of the village, went 60 feet in boulders, and one in the gap one-half mile west of the village went 25 feet in boulders with no water.

**NONFLOWING WELLS.**

**ANTONITO.**

Plate III, *A*, shows a view looking west from the vicinity of Antonito at the eastward-sloping lava-capped mesa about Los Mogotes Peak. The lava sheet can be seen to approach the level of the valley bottom and merge with it. This lava sheet is reached in various wells near Antonito. The town well reaches a depth of 400 feet. The first 235 feet is a cribbed shaft measuring 3 by 5 feet. In the bottom of this shaft a hole was bored 165 feet farther. A geologic section of the well, as reported by Mr. E. L. Myers, is as follows:

*Section of Antonito city well.*

Material.	Thick- ness.	Depth.
	<i>Feet.</i>	<i>Feet.</i>
Recent: Loose gravel and soil.....	35	35
Santa Fe formation:		
Solid lava.....	22	57
Lava ash.....	10	67
Gravel.....	25	92
Coarse boulders.....	35	127
Gravel and sand becoming finer.....	96	223
Conglomerate cement.....	3	226
Gravel and sand.....	9	235
Gravel and sand (bored).....	165	400



From this well there is pumped weekly 70,000 gallons of water, being the whole supply of the town for domestic purposes. A gasoline engine lifts the water 250 feet into a 35,000-gallon tank. The water is cold, tasteless, and hard.

The Denver and Rio Grande Railroad well is about 350 feet from the town well. The log of this well is as follows:

*Log of Denver and Rio Grande Railroad well at Antonito.*

	Thick- ness.	Depth.
	<i>Feet.</i>	<i>Feet.</i>
Recent: Gravel and bowlders.....	38½	38½
Santa Fe formation:		
Solid lava.....	35	73½
Lime cement.....	1½	75
Clay and bowlders.....	55	130
Marl.....	18	148
Cemented gravel.....	13	161
Marl.....	17	178
Cemented gravel.....	20	198
Marl.....	8	206
Cemented gravel (water).....	20	226
Loose gravel.....	1	227
Cemented gravel.....	13	240
Loose gravel.....	2	242

The water rises in this well 16 feet. With two hours' hard pumping the water is lowered to 2 feet, after which 4,000 gallons per hour can be taken out without affecting the water level. The analysis of this water is given in the table of analyses, page 112. The high percentage of this water in  $\text{CaCO}_2$  (whence its hardness) is noticeable, being exceeded in this respect only by the water from the Valley View Hot Springs, so far as the waters of the valley have been analyzed.

**MANASSA AND VICINITY.**

Manassa lies just south of the southernmost limit of flowing wells. Sharp little lava hills rise out of the valley half a mile south and 2 miles east of the town. Several attempts to obtain flowing water have been made within the limits of the town and in the vicinity. A well 125 feet deep in the northeast portion of the town went through bowlders. The water is reported to rise within 3 feet of the surface. A well in the schoolhouse yard, said to be 74 feet deep, struck water, which rises within 12 feet of the top.

During the winter of 1903-4 the State bored an experimental well in the schoolhouse yard. The log of this well, as furnished by the state engineer of Colorado, is as follows:

*Record of state well at Manassa.*

	Thick- ness.	Depth.
	<i>Feet.</i>	<i>Feet.</i>
Recent: Sand and bowlders.....	77	77
Alamosa formation:		
Clay.....	7	84
Clay and sand.....	5	89
Blue clay.....	3	92
Sand.....	62	154
Fine sand.....	14	168
Coarse sand.....	21	189
Coarse sand and fine gravel.....	11	200
Fine light sand.....	10	210
Coarse sand.....	70	280
Santa Fe formation (?):		
Lava bowlders.....	5	285
Dark sand and clay.....	11	296
Fine clay sand.....	9	305
Coarse sand.....	29	334
Coarse sand and bowlders.....	5	339
Fine clay sand.....	3	342
Red lava sand.....	18	360
Lava cobblestones.....	20	380
Clay and sand.....	55	435
Fine black sand; some clay.....	15	450
Volcanic ash (sand).....	62	512

It is evident from the preponderance of sand and gravel in this well that Manassa lies at the extreme edge of the alternating series of clays and sands which hold the artesian water under pressure, and that southwest of the town the clays will be found to be replaced altogether by sands and gravels. In that region water can not be found under sufficient pressure to reach the surface but will rise in the wells simply to the height of the general water level of the region or the underground water table.

Water was found through the entire depth of the well below the first 6 feet, except in strata of clay. The water rises within 26 feet of the surface of the ground. The well is 10 inches in diameter for the first 342 feet, and below that 8 inches in diameter.

A well on the Braiden ranch, in the SW.  $\frac{1}{4}$  sec. 20, T. 34 N., R. 10 E., is 133 feet deep with a rock bottom. The water rises within 3 feet of the surface.

The McDaniell place, in the northwest corner of sec. 33, T. 34 N., R. 10 E., has a well 33 feet deep, in which the water rises within 7 feet of the surface. The section of the well is as follows:

*Record of McDaniell well.*

	Thick- ness.	Depth.
	<i>Feet.</i>	<i>Feet.</i>
Recent:		
Soil, gravel, and clay.....	31	31
Gravel.....	2	33
Lava below.....		

Two miles northwest of Manassa, in the NW.  $\frac{1}{4}$  sec. 10, T. 34 N., R. 9 E., a prospect well was sunk by the Conejos County Oil Company to a depth of 318 feet. This well is about  $1\frac{1}{2}$  miles from the edge of the flowing-well area and about 30 feet higher. The record of the well, kindly furnished by Mr. W. O. Meier, is as follows:

*Record of Conejos County Oil Company's well.*

	Thick- ness.	Depth.
	<i>Fect.</i>	<i>Fect.</i>
Recent: Gravel and sand.....	70	70
Alamosa formation:		
Blue clay.....	12	82
Black sand (first flow, rose to -1 foot).....	8	90
Gravel, sand, and clay.....	155	245
Santa Fe formation:		
Lava.....	30	275
Very red granular rock.....	20	295
White sand (probably pumice).....	5	300
Black sand (water rose to -20 feet).....	4	304

**CAPULIN AND VICINITY.**

The wells in the vicinity of Capulin are dug wells. The usual depth is 30 feet, at which point they strike lava. A basin is made in the lava, into which the water percolates from the gravel.

North of Capulin the Knapp well is reported to show this section:

*Section of Knapp well.*

	Thick- ness.	Depth.
	<i>Fect.</i>	<i>Fect.</i>
Recent:		
Gravel and boulders.....	200	200
Hard stratum, not rock.....	2	202
Sand (drill rods dropped).....	32	234
Boulders.....	16	250

The water rose in the well about 100 feet, that is, within 150 feet of the surface. This well is far up on the alluvial slope, as indicated by the great excess of gravel and boulders.

East of Capulin and between that place and the Harvey ranch there are several deep wells. A mile and a half east of the village, 500 yards south of the center of sec. 10, T. 35 N., R. 8 E., several wells on the Palmer ranch reach lava at 64 and 66 feet, and afford a more permanent supply of water than the surface wells, 25 feet deep, which go dry in winter.

On the George S. Lovett place, in the SW.  $\frac{1}{4}$  NE.  $\frac{1}{4}$  sec. 11, a mile east of the well last described, a well gave this section:

*Section of Lovett well.*

	Thick- ness.	Depth.
	<i>Feet.</i>	<i>Feet.</i>
Recent: Boulders.....	55	55
Alamosa formation:		
Sand.....	60	115
Blue clay.....	60	175

Water was struck at 65 feet and rose within 5 feet of the surface.

At L. D. Eskridge's place, in the northwest corner of sec. 18, T. 35 N., R. 9 E., a well shows this section:

*Section of Eskridge well.*

	Thick- ness.	Depth.
	<i>Feet.</i>	<i>Feet.</i>
Recent and Alamosa formation: Sand and clay.....	150	150
Santa Fe formation: Lava.....	101 $\frac{1}{2}$	251 $\frac{1}{2}$

The water rises within 26 feet of the surface.

At S. E. Newcombe's, half a mile due east of the Eskridge well, two wells struck lava at 180 feet, and one of them penetrated it a depth of 20 feet. In the house well the water stands 10 feet from the surface, and in the barn well it rises within 3 feet of the surface.

At the schoolhouse, a quarter of a mile northeast of Newcombe's, the rock was struck at 185 feet and the water rises within 8 feet of the surface.

Joe Fred's well, in the SE.  $\frac{1}{4}$  sec. 31, T. 36 N., R. 9 E., gives this section:

*Section of Fred well.*

	Thick- ness.	Depth.
	<i>Feet.</i>	<i>Feet.</i>
Recent: Gravel.....	45	45
Alamosa formation: Clay.....	315	360
Rock below.....		

The water rose within 8 feet of the surface.

On the Harvey ranch a well in the SW.  $\frac{1}{4}$  sec. 5, T. 35 N., R. 9 E., is 265 feet deep, with a flow between 10 and 12 gallons a minute. There was a small flow just over the rock, but the present supply comes from crevices in the rock, into which the well is cased for some distance. There is some uncertainty as to the depth at which

rock was reached, but apparently it was about 232 feet, at which point, according to the state engineer's report, the first flow was obtained.<sup>a</sup> From the same source it is learned that the original flow was reported to be 100 gallons a minute. On the same ranch there are two other wells which reach rock, one at the house and another at the barn. The former is 6 inches in diameter to rock, which was reached at about 195 feet. There was a small flow here, but the bore, reduced to 4 inches, was continued to a depth of 229 feet. This well has a flow of several gallons a minute. The well at the barn, northeast of the house, is 265 feet deep, reaching the rock at about 220 feet. This well also has a flow of several gallons a minute, and originally the water rose from it 8 feet above the surface.

These wells on the Harvey ranch, though flowing wells, are described here because they form a continuous series with the other wells just described, which struck rock but did not get flowing water. It is apparent from the difference in depth at which rock is reached in the Joe Fred well and in the others that irregularities exist in the surface of the bed-rock lava. Possibly the northeastward limit of the upper lava flow lies between the Harvey wells and the Fred well. So far as is known to the writer, bed rock has not been struck in any well north and east of that point, except at the Lambert well, 1 mile northwest of La Jara, described on page 65.

The Eskridge and Newcombe wells are artesian, though nonflowing, but the Knapp, Palmer, and Lovett wells merely penetrate the underground water table, which is probably higher near La Jara and Alamosa creeks than it is at a distance from them.

**BOWEN SCHOOL AND VICINITY.**

Two miles southwest of Bowen school, in the northwest corner of the SW. ¼ sec. 33, T. 37 N., R. 8 E., a well 240 feet deep gives this section:

*Section of well in sec. 33, T. 37 N., R. 8 E.*

	Thick- ness.	Depth.
	<i>Fect.</i>	<i>Fect.</i>
Recent: Gravel and boulders.....	60	60
Alamosa formation:		
Hard clay.....	80	140
Sand (water).....	1	141
Clay.....	99	240
Gravel below.....		

This well is nearly 2 miles outside of the limits of flowing wells, and the water lacks 40 feet of rising to the top of the well.

<sup>a</sup> Rept. State Engineer of Colorado for 1889-90, p. 339.

Two miles east of north of Bowen, in the northeast corner of the NW.  $\frac{1}{4}$  sec. 11, T. 36 N., R. 8 E., a well passed through 60 feet of gravel and 160 feet of clay, striking water in gravel. The water rises within 14 feet of the surface.

Four miles west of Bowen, on the Gunbarrel road, in the northwest corner of sec. 31, T. 37 N., R. 8 E., the Strauss dug well is 70 feet deep in sand and gravel. It is well up toward the apex of the Cat Creek alluvial cone, and in the wet season (about June) it fills to the top. In the fall and winter it goes nearly dry, demonstrating an annual variation of about 70 feet in the ground-water level in this part of the alluvial slope. The well is about 150 feet higher than the rim of the flowing-well area.

#### MONTE VISTA AND VICINITY.

From Monte Vista to Alamosa Creek the Monte Vista canal is approximately parallel with the margin of the flowing-well area, and about a mile from it. As the Monte Vista canal is practically the upper limit of settlement in the valley, except along inflowing streams, there are few wells outside of the canal, but between the canal and the flowing-well margin there are many nonflowing wells that penetrate the artesian water-bearing beds.

Two miles west of Monte Vista, in the NE.  $\frac{1}{4}$  NE.  $\frac{1}{4}$  sec. 34, T. 39 N., R. 7 E., on the second terrace of the Rio Grande, the water lacks 18 feet of rising to the surface. One mile south, in the NE.  $\frac{1}{4}$  sec. 3, T. 38 N., R. 7 E., a well 125 feet deep failed to get any water whatever. In the southeast quarter of the same section two bore holes, 66 and 76 feet deep, struck water which failed to rise. They are reported to strike rock, but more probably they struck boulders.

#### DEL NORTE.

The municipal water supply of Del Norte is pumped from the Rio Grande into a small reservoir in the side of a small hill just south of the town, from which it is distributed. Wells in town strike the underflow of the Rio Grande at short distances, furnishing a plentiful supply of wholesome water.

In 1890 an artesian well was bored at the intersection of two of the main streets of the town, reaching a depth of 450 feet. A very small flow of water was obtained, at first a stream not larger than a lead pencil, which afterward strengthened to a flow of 2 gallons a minute. The water is reported to rise from beneath a sheet of lava, though details of the geologic record of the well are not available. The water has a temperature of 54° and a decided taste of soda. No analysis is available.

## LA GARITA AND VICINITY.

Wells east and south of La Garita strike water in the gravel of the alluvial slope. A well at the Dunn ranch, near the center of sec. 16, T. 41 N., R. 7 E., at 180 feet in depth, struck quicksand and water, which rose within 10 feet of the surface. This well is about 2 miles from the limit of flowing wells. To the south is the great triangular alluvial fan of the Rio Grande. The lower portion of the fan, adjacent to the flowing-well area of the valley, affords wells in which the water rises under artesian pressure to a greater or less height, according to the distance from the flowing-well limit. But in the upper part, toward the apex of the fan, the clay strata of the valley thin out and give place to sand and gravel beds. Wells in this area will be bored in gravel and sand and will yield water whose level, depending on the general water level in that region, will be higher near the Rio Grande and lower at a distance from the river.

## SAGUACHE AND VICINITY.

The limiting line of the flowing-well area crosses Saguache Creek 3 miles below Saguache, which lies in the creek valley somewhat within the margin of the foothills and is surrounded by isolated lava hills. The chances of striking any water but the underflow of the creek depend upon striking gravel beds beneath the lava containing water under pressure. Several attempts to strike deep water have been made, one by the State, one by the town, and others by private citizens, but none have struck flowing water. The information recorded below has been kindly communicated by the Hon. J. H. Williams, county judge of Saguache County.

The state well, 1 mile northwest of town, reported to be 1,100 feet deep, struck water at about 75 feet, which rose within 12 or 14 feet of the surface. No record is available as to geologic formations penetrated. The well did not succeed in getting a better flow of water with greater depth.

The park well, in the public park within the town limits, is reported to be 665 feet deep. Water was struck at 65 feet in gravel and rose within 12 feet of the surface.

The Jordan well, just south of the town, is 180 feet deep, with the water level 8 feet from the surface; the Curtis well, in the eastern part of town, is 100 feet deep and has water at the same level. Several other wells in the town get water at about 65 feet, which rises to a level 8 or 12 feet from the surface.

## VILLA GROVE AND VICINITY.

The village of Villa Grove is situated in the northern arm of the valley, which extends up the valley of San Luis Creek and the upper portion of which is known as Homans Park. The village lies about

9 miles above the upper limit of flowing wells and in all probability some distance also beyond the extreme limits of the sand and clay series in which the artesian water of the valley is found. Owing to the proximity of mountain highland on either side of this narrow tongue of the valley, the sediments consisted largely of sand, gravel, and boulders without the clay strata necessary to confine the water. The domestic water supply is derived from shallow wells which reach the underflow of Kerber Creek.

The Denver and Rio Grande Railroad in 1891 sunk a well at Villa Grove to a depth of 960 feet in gravel and sand with no clay. The water rose within 100 feet of the top. In 1899 the well was accidentally clogged, and since then it has not been in use.

On the Pitzer ranch, about 6 miles southeast of Villa Grove and 2 miles east of Chamberlain Hot Springs, in the NE.  $\frac{1}{4}$  SE.  $\frac{1}{4}$  sec. 8, T. 45 N., R. 10 E., a well between 300 and 400 feet deep struck water, which rose within 12 feet of the surface. This well probably strikes the artesian water of the valley, as flowing wells are obtained 3 miles to the south.

#### CRESTONE AND VICINITY.

The water supply of Crestone is derived from shallow wells, in the gravel of the alluvial slope. These wells reach the underflow of Crestone Creek, which meanders through the village, and they furnish an abundance of water, which, from the situation of the town just at the base of the mountains, is pure and cold. The danger of contamination is wholly local.

On the Baca grant, a mile and a quarter southwest of the village, in the fork of North and South Crestone creeks, a bore went 410 feet in boulders, with no water. A half mile farther west, at the ranch house, in a well 496 feet deep, the water rose to a level 6 feet below the surface. On Dead Man Creek a bore 1,100 feet deep was all in sand with no water. A mile and a half east of Antelope Springs a 1,000-foot bore yielded no water. These wells on the grant are in the alluvial slope of the Sangre de Cristo Range; and as the clay members of the valley formation do not reach that far there is no confining layer to retain the water under the pressure necessary to yield a flow.

#### BALDY STATION AND VICINITY.

At the Willie Hansen ranch, 2 miles northwest of Baldy station, on the Denver and Rio Grande Railroad, a number of wells have been bored just about at the margin of the flowing-well area. One in the NE.  $\frac{1}{4}$  sec. 17, T. 37 N., R. 12 E., is 500 feet deep, reported all in sand. The water rises within 3 feet of the surface. A half mile due east is another in which the water rises within 10 feet of the top. Two miles due north of Baldy station, near the middle of the north side of



sec. 10, T. 37 N., R. 12 E., a well is reported 300 feet deep, all in sand, in which the water lacks 8 feet of rising to the surface. Near the middle of the west side of sec. 36, T. 38 N., R. 12 E., a well 300 feet deep in sand and gravel is reported to have struck no water whatever. Another well in the NE.  $\frac{1}{4}$  sec. 24, in the same township, well up on the alluvial slope of the Sierra Blanca, struck no water. Though it is evident that the clay beds of the water-bearing series are replaced at about this point by sand and gravel, it is not likely that they terminate so abruptly. It is probable that small clay beds have been overlooked in the wells near the edge of the flowing-well area.

#### FORT GARLAND AND VICINITY.

The surface wells which furnish the domestic water supply of Fort Garland strike the underflow of Ute Creek. The principal danger of pollution lies in the pastures along the valley of the creek above the town.

On the south bank of Trinchera Creek, in the SW.  $\frac{1}{4}$  sec. 31, T. 30 S., R. 72 W., 4 miles southwest of Fort Garland, a well on W. H. Myers's ranch, 108 feet deep, struck water which rose within 18 inches of the surface. At Frank Beckwith's, in the southwest corner of the SE.  $\frac{1}{4}$  sec. 26, T. 30 S., R. 73 W., a well in Trinchera Valley gave this section:

#### *Section of Beckwith well.*

	Thick- ness.	Depth.
Recent:	<i>Feet.</i>	<i>Feet.</i>
Soil.....	4	4
Small boulders.....	31	35
Alamosa formation: Clay and sand.....	118	153

The water rises within 6 feet of the top of the well.

#### SPRINGS.

The valley affords numerous springs, both large and small. These, with a few exceptions, emerge near the junction of the foothills and the valley bottom. They have mostly the normal temperatures of the shallow artesian waters of the valley, but two springs in the north end of the valley and one near the south end have rather warm temperatures.

*McIntire Springs.*—The largest group of springs in the valley is that formerly known as Los Ojos, or commonly as McIntire's Springs, on the south side of Conejos River in the northeast corner of sec. 13, T. 35 N., R. 10 E. These springs rise in the bottom just at the foot of one of the San Luis Hills, and some of the springs appear to come up through crevices in the lava. The group is limited to an area not more than 300 feet in diameter, and they all merge into one stream.

The flow from these springs, which is practically constant and does not vary with rainfall, has been measured many times and is found to be about 21 second-feet. The temperature of the stream comprising the united flow of the springs is 60°. Some of the smaller springs have a temperature of 54°, but most of the individual springs are either just over or just under 60°. As these springs rise against or even through comparatively recent lava rocks, their temperature is not a reliable clue to the depth from which they come. A view of these springs looking toward the west, up the valley of Conejos River, is shown in Plate XIII, B. An analysis of the water is given in the table on page 112.

The flow of these springs was filed upon at an early date by the inhabitants of the Mexican village of Los Sauces for irrigation purposes, for which its temperature makes it peculiarly valuable in the early season.

*Dexter Spring.*—Dexter Spring is on the Austin ranch (formerly the Dexter tract), in the NE.  $\frac{1}{4}$  sec. 9, T. 35 N., R. 11 E., 2 miles northeast of McIntire Springs, and like those springs rises along the edge of the lava bench, which extends from the base of Cerro de los Ojitos, the northernmost of the San Luis Hills, west of the Rio Grande. An analysis of water from this spring is given in the table of analyses, page 112. The temperature is reported to be 71°.

*Other springs along Conejos River.*—Other smaller springs emerge near the base of the San Luis Hills along Conejos River from a point near its mouth up to the vicinity of Manassa, as was noted on pages 17 and 38, where the supposition was advanced that the water of these springs rises from the water-bearing beds of the Alamosa formation, where they abut against the lava of the Santa Fe formation of the San Luis Hills.

*Spring Creek.*—Spring Creek has its head in sec. 12, T. 37 N., R. 7 E., half a mile west of the Gunbarrel road and just under the rise of the steeper alluvial slope. Water rises over an area 15 by 40 feet, flowing more than a cubic foot a second. It is augmented by seepage until at the point where it crosses the Gunbarrel road it has a volume of several second-feet. The flow is affected by melting snows in the mountains. It has a temperature of 57°.

*Russell Springs.*—Russell Springs are situated in the NE.  $\frac{1}{4}$  sec. 24, T. 43 N., R. 7 E. These springs rise in a grassy area 40 acres or so in extent, underlain by a peaty black mud. In this area about twenty-five springs display temperatures ranging from 44° to 56°. The temperature where the water crosses the Gunbarrel road is about 52°. The water has no taste. The water from these springs drains eastward 2 miles into Russell Lakes.

*Hunt Springs.*—Hunt Springs are in the NE.  $\frac{1}{4}$  sec. 3, T. 44 N., R. 8 E., at the foot of the small lava hill 4 miles east of Saguache.

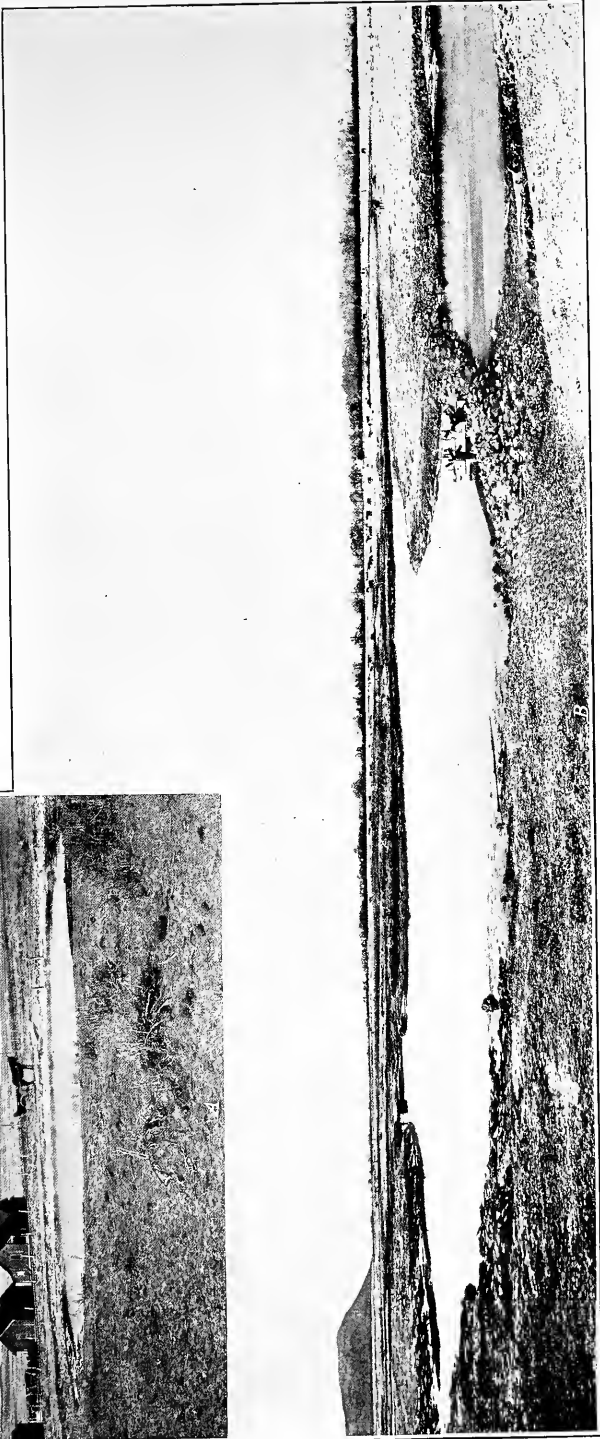

A. CHAMBERLAIN HOT SPRINGS, LOOKING TOWARD PONCHA PASS. B. MCINTIRE SPRINGS.

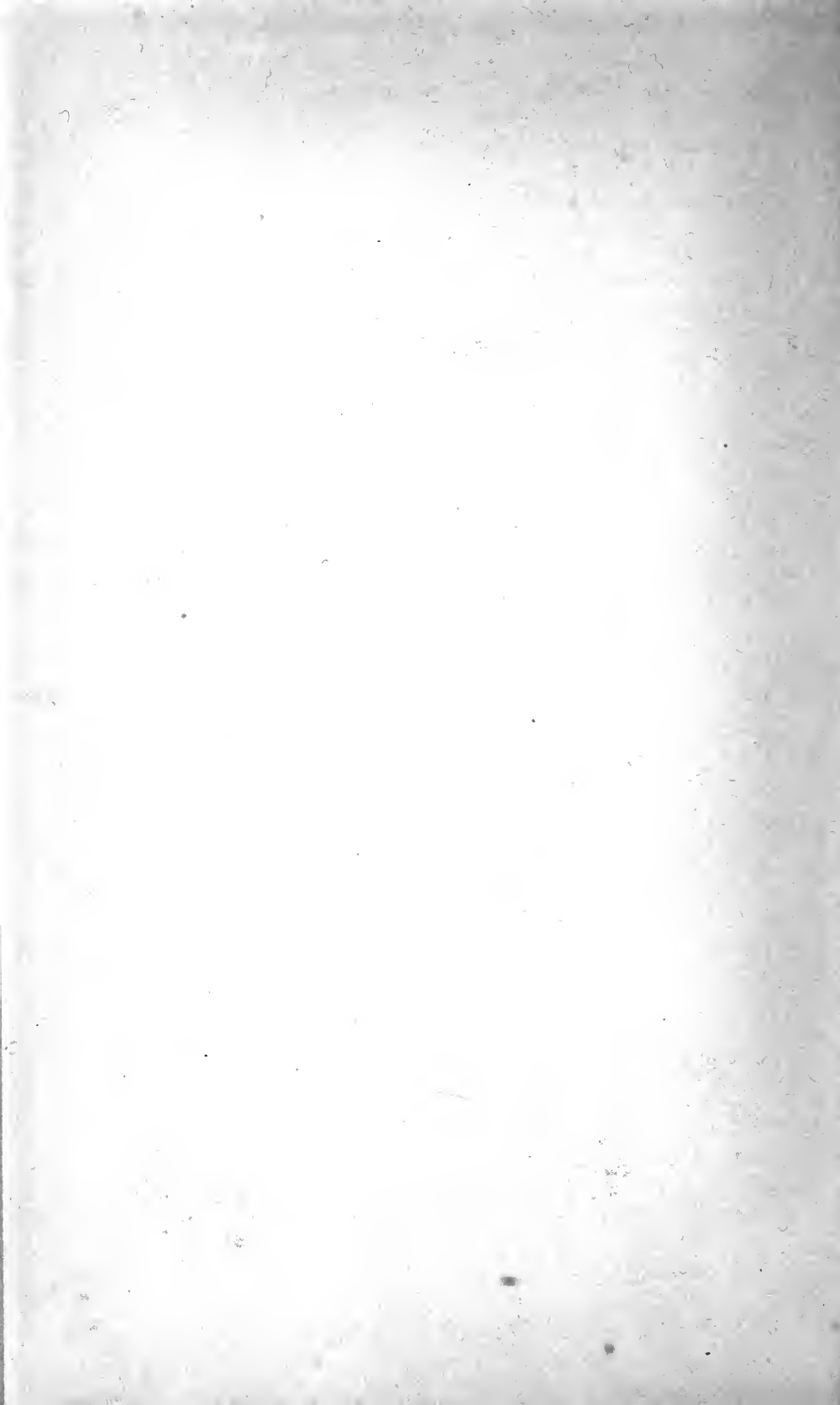

The group comprises about a dozen springs which range in temperature from 43° to 52°. They emerge over an area about 1 acre in extent and nearly on a level with the valley bottom to the east, in which the overflow from the springs forms large marshy ponds, as shown in Plate XII, *B*. The water has no taste and forms no deposit.

*Antelope Springs.*—Antelope Springs are situated near the middle of the south side of the Luis María Baca Spanish grant. They were not visited by the writer.

*Medano Springs.*—There are two springs on the Medano ranch. The Big Spring is in the NW.  $\frac{1}{4}$  sec. 2, T. 40 N., R. 12 E. This spring emerges in a circular bed of quicksand 100 feet in diameter, lying at the head of a gully 15 feet deep, which reaches back into the edge of the great dune area. The stream where it first emerges is not large, but it is much increased below by seepage. The temperature of the stream 100 feet below the spring is 51°. The Little Spring lies 2 miles southeast of the Big Spring, in the SW.  $\frac{1}{4}$  sec. 12 of the same township, and is similar to it except in size. These springs, heading in the edge of the great dune area, are popularly and no doubt correctly believed to be the reappearing waters of Mosca and Medano creeks, which disappear beneath the sand several miles to the east.

*Washington Springs.*—Washington Springs are just north of the Denver and Rio Grande Railroad, in the northeast corner of sec. 14, T. 37 N., R. 11 E. They emerge from the base and even from the top of a small sand dune on the edge of the terrace which is the northern continuation of Hansen Bluff. Those at the base of the mound on the north side flow about 10 gallons a minute. Another forms a pool at the very top of the mound. The temperature of the water is 52°. The dune is covered with grass and is quite the highest point in the vicinity. Presumably the vegetation growing around this spring caught and held the drifting sand, gradually building up the mound, and carrying the spring up with it. On the lower ground, south of the railroad, in the northwest quarter of the same section, a mound 50 yards in diameter has been similarly built up to a height of 20 feet or so. Several small springs emerge from the top and slopes of the mound.

*Chamberlain Hot Springs.*—The Chamberlain Hot Springs are in the southeast corner of sec. 12, T. 45 N., R. 9 E., and in the SW.  $\frac{1}{4}$  sec. 7, T. 45 N., R. 10 E., near the station on the Denver and Rio Grande Railroad. East of the railroad and just south of the station, in sec. 12, a number of springs bubble up in a large pool about 50 feet in diameter. The temperature is 90° at the edge but is probably higher near the center, where the springs rise. Two other small springs, 25 and 50 yards southeast, have temperatures of 114° and 112°, respectively. The water of the large pool has no taste and shows no tufaceous deposit. Several species of water bugs and an

abundance of the plant *Chara* thrive in the water. The spring was formerly used as a swimming pool, and the water was also piped to a bathing house farther east. The pool, somewhat obscured by rising steam, is shown in Plate XIII, A.

The springs in sec. 7 emerge from three small mounds about 50 yards each in diameter and ranging from 20 to 35 feet in height, built up of laminated tufaceous sinter deposited by the springs. No commercial use has been made of these springs for a number of years and no analysis of the water is available.

The springs of the south mound are the most active. The spring by the bath house has a temperature of 127°. A slight but pronounced taste of both soda and iron is evident. There is a yellowish precipitate in the stream flowing away from the spring, and green algæ grow in the spring and along the stream. A pool 20 feet in diameter on the summit of the mound has a temperature of 72°. Other springs near by have temperatures ranging from 128° to 131°.

The east mound has springs on the east and north sides with temperatures ranging from 112° to 124°. The spring on the summit of the mound is extinct.

The north mound is the largest and highest of the three, being about 40 feet high. The springs upon this mound are now extinct, except a group upon a bench on the southeast edge of the mound. These range in temperature from 120° to 130°.

*Valley View Hot Springs.*—Valley View Hot Springs are in the SW.  $\frac{1}{4}$  sec. 31, T. 46 N., R. 10 E. They emerge from the mountain side a short distance above the upper limit of the alluvial slope. The country rock consists of quartzite. The springs are five in number, three being situated on the north branch of the stream, one on the middle branch, and one, several hundred feet higher up the mountain side, on the south branch. The north spring has a temperature of 72°. The next spring to the south and the largest one of the group, over which there has been built a bath house, has a temperature of 95°. The third spring to the south has a temperature of 87°. The fourth spring, the one on the middle branch, has a temperature of 96° and the one on the south branch a temperature of 99°. The analysis of the largest spring is shown in the table of analyses, page 112. The springs have been improved by the erection of a hotel, a bath house, and several cottages and afford a modest business as a resort.

*Hot Creek Springs.*—A small stream emptying into La Jara Creek, near Capulin, is known as Agua Caliente, or Hot Creek. The higher temperature of the water in this creek, which renders it so desirable for purposes of irrigation in the early season, is due to hot springs which occur in its upper course.

## CHARACTERISTICS OF THE ARTESIAN BASIN.

## GROUPING OF WELLS.

A glance at the map will show that by far the greater number of wells in the San Luis basin are along its western slope. Various factors have contributed to this segregation. The principal one, perhaps, has been the presence of greater irrigation systems on that side of the valley and consequent greater population; but another important cause is the fact that the slighter inclination of the strata on that side of the valley has made the matter of obtaining an artesian flow much simpler, involving less chances of failure and less expense.

## VARIATIONS IN FLOW.

*Seasonal variations.*—Near the margin of the area of flowing wells there is a decided periodical variation in pressure or head. Just on the limiting line there are a number of wells that flow during a certain portion of the year and have to be pumped during the remainder of it. The variation in head in these wells is not accurately determined but is about 4 feet. The same variation affects wells within the limits of the flowing-well area, but it there shows itself as a slightly increased or decreased flow and is not so manifest as in wells along the critical line. These wells, with the seasonal intermissions, flow during the summer and fall and do not flow for the rest of the year. As this is the season of irrigation the flow of the wells is popularly said to "come up with the sub." (that is, with the rise of the water table due to subirrigation); and this is probably true, though of course there is no direct connection of the ditch water with the aquifer. The water in the water-carrying stratum is under constant hydrostatic pressure, tending to rise to the surface and pressing upward always against the confining clay bed above. Any increase of weight upon this clay bed is transmitted downward to the aquifer, which, being thus under greater pressure, yields greater flows than before. The water which is put upon the ground in irrigation adds a very definite increment to the pressure upon the aquifer and it is therefore true that the flow rises with the ditch water. Likewise, the rainfall during the showery season adds to the general pressure and helps to increase the head. The seasonal fluctuation due to irrigation is hence closely allied in principle to the tidal fluctuations in artesian wells at the seashore.<sup>a</sup>

*Gradual failure of wells.*—Several factors contribute to cause the gradual failure of wells. Among these one of the most obvious is the growth of a green alga. This lines the inside of a vertical pipe down for a foot or so, probably as far as light is efficacious, and by

<sup>a</sup> For a summary of the literature relating to tidal fluctuations in artesian wells near the seacoast see Water-Supply Paper U. S. Geol. Survey No. 155, 1906, pp.65-69.

its continued growth often constricts the opening so that the water is forced to a height; and the considerable pressure thus exerted on the well doubtless to an appreciable extent reduces its flow.

Another possible cause of the gradual failure of wells is a reduction of the porosity of the sand bed through which the water comes to the bottom of the well. This has been popularly expressed as a "silting up of the water bed." It seems more reasonable to suppose that the free silica, in which the analyses show the water to be especially high, is by the reduction of pressure at the bottom of the well in part precipitated about the grains of sand in the aquifer adjacent to the bottom of the well, which tends to seal the interstices and to reduce the porosity of the bed. For most of their long journey through the beds of granitic and volcanic sand the artesian waters are undoubtedly augmenting their silica content, as shown by the fact that the silicic acid in water from the Rio Grande at Del Norte is 24 parts per million, whereas that of various wells in the San Luis Valley ranges from 38 to 106 parts per million. But this fact is not in any way inconsistent with the theory that some precipitation of silica may take place as the waters pass from the sands and gravels of the aquifer to the opening at the bottom of the well tube. Decisive proof of this deposition of silica would be had if secondarily enlarged grains of sand should be brought up in cleaning out some old well that had slowly failed. The writer, though repeatedly trying, has as yet failed to obtain such material with which to test the theory.

But presumably the greater number of cases of gradual failure of wells are due to the increase in number beyond the capacity of the aquifer to furnish the full flow for each. The minimum distance from one another at which wells may be put down without affecting the common flow is difficult to determine and depends on the size of the bore, the capacity of the aquifer, and the artesian pressure. It has been shown that the wells in the town of Monte Vista so seriously affect one another that they have ordinarily a uniform flow. The distance there between the wells is from 50 to 200 feet. A mile northwest of La Jara, on William Lambert's place, of two wells 150 feet apart the newer well seriously affected the flow of the old well. It is noticed in all the towns of the valley that the flows now obtained are not so strong as the flows formerly obtained at the same depth, though the adjacent wells may not seem to be affected by the sinking of a new well. The normal flow of wells in towns is often so concealed by the piping or restricted by partial use only that it might be seriously impaired without the fact becoming apparent. Such a failure, of course, may be due in part to other causes, but it is undoubtedly due mainly to the increase of wells. It seems certain that the large wells may be placed as close as 440 yards, and reason-



ably sure that they may be as close as 220 yards, without affecting one another. Smaller wells can of course be placed still closer without mutual injury. If it is desired to have two or more large wells close together, in order that the combined flow may be used for irrigation or stored in a reservoir, they may be so placed if they are bored to different flows and all but the lower flow is cased off from the deeper well. In this way there will be no interference. Instead of sinking two separate wells of different depths, the same effect may be gained by reducing the bore of a large well and continuing it to lower flows, the water from the deeper flows coming up through the smaller inside casing. However, separate wells will in general be preferable, owing to the difficulty of cleaning and repairing multiple wells.

By far the greater number of wells, as will be seen later, are cased only to the first solid clay, a depth varying ordinarily from 10 to 40 or 50 feet. The bore is continued through the various water-bearing beds until a suitable flow is reached. As long as this deeper flow of higher pressure continues the water from the upper water beds will not come into the bore and there will be no mingling of the different flows; but if the well is plugged or is choked near the top, the lower flows, which are under greater pressure, will spread out in the upper beds that are under less pressure, so that the pressure tends to be equalized in the upper and lower flows, and as a result the pressure and consequently the yield of the lower flows are weakened. This process has taken place to such an extent toward the center of the town of Monte Vista that the yield from the various flows is identical, and likewise the temperature.

*Sudden failure of wells.*—In almost all cases sudden failure is due to the caving away of the clay walls of the well. In a well that is not cased the caving in of the clay anywhere along the bore may shut off the water from below the caved place. In a well that is cased to the sand bed furnishing the flow ordinarily there is a rather large cavity in the sand at the bottom of the casing, resulting from the sand being carried up and thrown out of the well. Occasionally large pieces of the clay bed above may tumble into this cavity and clog the bottom of the casing. In the vicinity of Hooper, and northward on the Kinney ranch, the practice is to let the 1-inch pipe that serves as a drill rod remain in the well after completion. This rod, projecting downward below the casing and into the cavity at the base of the well, ordinarily prevents the complete closure of the well by any falling chunk of clay.

*Irregularities in flows from the same aquifer.*—Adjacent wells that strike the same water bed may have very different flows. These irregularities are probably to be explained by the irregularities in thickness or porosity of the water-bearing bed. The rate at which

water passes through sand varies with the size of the sand particles, being greater for the coarser varieties. For this reason the gravel flow obtained in certain parts of the valley is a very free, strong flow. Local variations in the same bed of sand therefore exert a very definite effect upon the quantity of flow.

As the rate of flow through sand of a given size is fixed, the volume of flow from any bed of sand of that size depends on the thickness of the bed. It is not to be presumed that the beds of sand in the valley, though known to be of great extent and persistence, are of the same thickness throughout. Any formation built up more or less in delta form, as are the deposits of the Rio Grande alluvial fan, must of necessity differ in thickness from place to place, and such differences are undoubtedly ample to account for any variations in flow from the same bed.

#### VARIATION IN TEMPERATURE.

##### VERTICAL VARIATION.

The vertical range in temperature observed in the wells of the valley is from a minimum of  $45^{\circ}$  in shallow wells to a maximum of  $75^{\circ}$  for the Bucher well at Alamosa. The increase of temperature with depth is very regular; estimated from the deep cased wells near Alamosa it is  $1^{\circ}$  for  $28\frac{1}{2}$  feet.

The minimum temperature is found in wells on the low ground near the Rio Grande north of Monte Vista. Southward along the Gunbarrel road and southeastward along the flowing-well limit to the vicinity of La Jara the shallowest wells have temperatures of about  $46^{\circ}$ . Southeast of La Jara along Conejos River the shallowest wells have temperatures of  $50^{\circ}$  to  $52^{\circ}$ . North of Monte Vista along the Gunbarrel road the temperature of the first flow likewise increases and in the vicinity of Center it is about  $51^{\circ}$  or  $52^{\circ}$ . Farther north, in the Veteran neighborhood, the temperature is lower again,  $46^{\circ}$  and  $47^{\circ}$  in wells reaching the first flows. These temperatures continue to the vicinity of Russell Springs, but from there to Swede Corners,  $2\frac{1}{2}$  miles north, there is an increase in temperature of  $10^{\circ}$  in wells of practically the same depth. The area of excessive temperature about Swede Corners has already been described (p. 75). On the east side of the basin the temperatures are very regular and such as would normally be expected, that is to say,  $46^{\circ}$  and  $47^{\circ}$  for the first flow.

It is noticeable that the wells of lowest temperature on the west side of the valley are near the courses of the larger streams and that the higher temperatures are found in the interstream areas. The waters of these streams, derived from melting snow for a large part of the year, are notably cold. Daily observations at Del Norte give the

following mean temperatures of the Rio Grande from July 1, 1905, to November 30, 1906, excluding January, February, and March, during which no gage readings are made:

*Monthly mean temperature, in degrees Fahrenheit, of the Rio Grande at Del Norte.*

[Richard D. Adams, United States Geological Survey, observer.]

	1905.	1906.
April.....		37.6
May.....		44.0
June.....		47.5
July.....	57.2	53.5
August.....	56.6	56.0
September.....	51.0	50.0
October.....	40.6	40.5
November.....	35.4	34.7
December.....	35.8	.....
Monthly mean.....	46.1	45.5
Mean of all observations.....	45.8	

It will be noted that the mean for the period of the observations corresponds closely to the temperature of the coldest wells, namely, 45°. If the observations covered the remaining portion of the year, the winter months would doubtless lower the mean to a point below that of the coldest wells. Water of this mean temperature entering the artesian system is warmed in its passage through the aquifer and, rising rapidly to the surface through the wells, emerges at practically the temperature of the aquifer in the region of the well; but in acquiring this temperature it has abstracted heat from the aquifer. The general loss of heat by radiation from the surface of the earth is counterbalanced by an equivalent upward flow of heat from the internal supply; but in beds as nearly homogeneous as those of the artesian system this increment of heat will be uniform and evenly supplied over the whole area, and thus those areas from which most heat has been abstracted will still remain below the normal temperature. The different beds of the system tend then to become colder and colder, and the first portions to reach the ultimate limit (the mean temperature of the river water) will be those nearer the intake—that is, along the larger streams. That this limit has been practically reached north of Monte Vista has been pointed out above.

This local excessive cooling of the upper strata of the earth is apparently the explanation of the high temperature gradient of 1° for 28½ feet as compared with 1° for 50 or 60 feet, the average increase as found in deep dry wells, shafts, and mines.

The wells with higher temperatures about Swede Corners and along the lower course of the Conejos, with adjacent areas of lava, in all probability derive their excess of heat from subterranean bodies of uncooled igneous rocks. The hot springs which have been described seem likewise to owe their temperature to such a source.

## SEASONAL VARIATIONS.

The impression obtains to some extent that the wells of the valley are warmer in winter than in summer. At first thought this would seem to be a delusion, due to the difference in air temperatures in the different seasons affecting the personal standard of comparison. However, in view of the fact that water from the streams enters the aquifers at all seasons of the year with varying temperatures, and that the draft on the wells, and consequently the rate of transmission of the water through the sand, is much greater in the irrigating season, it seems not impossible that there may be seasonal variations. A series of temperature readings was taken of a well in the vicinity of Monte Vista and of two near La Jara.

*Variation in temperature of artesian wells.*

Date (1906).	1.	2.	3.
July 16.....	47.2	48.8	.....
August 1.....	47.5	48.7	.....
August 16.....	47.4	48.7	45.6
September 1.....	47.4	48.8	45.8
September 16.....	47.3	48.8	45.7
October 1.....	47.2	48.9	45.7
October 16.....	47.3	48.6	45.8
November 1.....	47.3	48.6	45.8
November 17.....	47.2	48.4	.....
December 1.....	47.2	48.3	.....
December 16.....	47.2	48.2	45.8

1. La Jara, Eskridge well; SE.  $\frac{1}{4}$  sec. 15, T. 35 N., R. 35 E.; L. A. Norland, observer.

2. La Jara, Mill well; L. A. Norland, observer.

3. Monte Vista, SW.  $\frac{1}{4}$  sec. 19, T. 39 N., R. 8 E.; G. M. Whitead, observer.

These readings show that such variation as exists is measured in tenths of a degree. Well 1 (excluding the first reading, which is probably in error) shows a definite and regular decrease in temperature in the winter. This is a 6-inch well with a small flow. The column of water therefore moves rather slowly up the casing, and there is opportunity for winter ground temperatures to affect the temperature of the water, which they undoubtedly do. In well 2, until after October 1, there was a large flow, and up to that date the readings are valuable. After that date the flow was so reduced that the slow-moving column of water in the well was affected by the ground temperature. Up to the time mentioned the readings indicate a slight rise in temperature. Readings taken at short intervals during a warm day at each of these wells showed no measurable diurnal variation. Well 3, near the limit of flowing wells and the artesian intake from the Rio Grande, is more favorably situated to show such a variation than either of the other two wells. The readings seem to indicate a rise of two-tenths of a degree. It is regrettable that the observations on this well are not extensive enough to be more decisive.

QUALITY OF THE WATER.

In the table on page 112 there have been brought together all available analyses of the well and spring waters of the San Luis Valley. They were variously expressed as grains per United States gallon, grains per imperial gallon, or parts per hundred thousand, but have been uniformly reduced to parts per million and put in terms of ions.

The following determinations of total salts were furnished by the United States Department of Agriculture:

*Total salts determined by electrolysis, in well waters of San Luis Valley.*

[Bailey E. Brown, analyst.]

	Parts per million.
Well, northwest corner of the NE. $\frac{1}{4}$ sec. 5, T. 40 N., R. 9 E.....	87
Center, town well.....	87
Center, hotel well.....	90
Elliott well, NE. $\frac{1}{4}$ NE. $\frac{1}{4}$ sec. 13, T. 40 N., R. 7 E.....	90
Monte Vista, Elliott well.....	89

The accuracy of the conductivity method is proportional to the degree of dissociation of the salts in solution. Since these waters are among the best waters of the valley and are in all respects similar to the waters at La Jara and Monte Vista, which yield by gravimetric methods 152 and 156 parts per million of solid matter, respectively, it follows that the dissociation of solutes in the valley water is far from complete. The discrepancy is probably to be ascribed largely to the notable quantity of free silica in these waters. Though not to be relied upon, therefore, to give a correct notion of the total solids, the determinations nevertheless show the relative salinity of the waters included and demonstrate the uniformity of quality over the area covered by the samples.

The analyses in the table (p. 112) with few exceptions, have been made for commercial purposes, mostly with a view to determining the fitness of the waters for boiler use. In certain of the analyses credited to W. P. Headden, however, the process was carried further and supplementary sanitary determinations were made. The amounts of free ammonia and albuminoid ammonia present in two deep artesian wells and two springs are given in the following table:

*Ammonia in San Luis Valley waters.*

[Parts per million.]

	Free ammonia.	Albuminoid ammonia.
Bucher well.....	0.112	0.034
McNieland well.....	.050	.006
McIntire Springs.....	.106	.092
Dexter Spring.....	None.	.082

## Analyses of ground water in San Luis Valley, Colorado.

[Parts per million.]

Nearest post-office and source.	Date.	Depth.	Color.	Silica.	Iron and alumina.	Calcium.	Magnesium.	Sodium.	Potassium.	Chlorine.	Sulphate radicle.	Carbonate radicle.	Volatiles.	Total solids.	Analyst.
Alamosa:															
Alamosa Milling and Elevator Co. well.	Apr. 19, 1893	680	.....	54	1.3	9.6	9.7	35	.....	5.2	14	72	.....	200	Dearborn Drug and Chemical Co.
Blanca farm well.	Feb. 3, 1904	840	.....	60	1.9	5.2	4	67	.....	6.7	11	84	2.0	240	Do.
Bucher well.	.....	+1,000	.....	106	.57	5	.2	42	3.8	Trace.	7.9	31	22	228	W. P. Headden.
Do.	.....	+1,000	.....	48	Trace.	7.6	.....	32	.....	.....	.....	53	.....	a 179	Unknown.
McIntire well.	.....	48	.....	90	.89	3.6	.56	41	3.1	Trace.	9.7	75	.....	251	W. P. Headden.
Antonito: Denver and Rio Grande Railroad well.	.....	242	.....	40	32	43	.86	20	.....	40	2.0	92	.....	b 298	Kennicott Water Softener Co.
Hooper:															
Well in sec. 6, T. 40 N., R. 10 E.	.....	.....	.....	.....	.....	.....	15	162	55	.....	16	73	.....	c 745	U. S. Dept. Agriculture.
Garrison Mill and Elevator Co. well.	Oct. 14, 1897	740	.....	76	3.6	2.6	2.0	520	.....	7.3	Trace.	679	.....	.....	Dearborn Drug and Chemical Co.
Denver and Rio Grande Railroad well.	.....	614	.....	38	.....	.....	.....	408	.....	2.1	.....	.....	134	1,112	Von Schultz & Lov.
La Jara: La Jara Milling and Elevator Co. well.	.....	340	.....	41	.99	25	3.1	8	.....	3.4	36	31	2.8	152	Dearborn Drug and Chemical Co.
Moffat: Denver and Rio Grande Railroad well.	.....	1,045	.....	43	.....	.....	.....	47	.....	3.0	.....	58	53	204	Von Schultz & Lov.
Monte Vista: Monte Vista Milling Co. well.	Mar., 1897	300	.....	42	1.3	19	2.3	24	.....	7.3	2.4	57	.....	156	Dearborn Drug and Chemical Co.
Mosca:															
Town well.	.....	400	.....	64	3.3	3.3	.92	389	8.1	.....	.....	525	91	a 1,091	W. P. Headden.
Well on Andersen ranch.	Feb. 3, 1904	500	.....	50	7.9	9.2	11	555	.....	6.7	Trace.	759	50	e 1,400	Dearborn Drug and Chemical Co.
Well of Mosca Milling and Elevator Co.	.....do.	600	.....	66	1.9	5.2	4.0	572	.....	6.7	2.9	755	114	e 1,418	Do.
Well in sec. 35, T. 39 N., R. 10 E.	.....	500	.....	5.4	4.7	9.6	12	554	.....	10.4	2.0	750	119	1,474	W. P. Headden.
Well in the NW $\frac{1}{4}$ NW $\frac{1}{4}$ sec. 8, T. 32 N., R. 11 E.	Feb. 3, 1904	800	.....	48	1.3	9.6	2.7	130	.....	51	12	138	42	e 396	Dearborn Drug and Chemical Co.
Orient: Valley View Hot Springs.	.....	.....	.....	18.1	f .77	53	14	.....	4.7	1.3	69	142	.....	306	Regis Chauvenet.
Los Sauces:															
McIntire Springs	.....	.....	.....	52	1.2	23	2.8	15	2.6	.....	28	45	14	175	W. P. Headden.
Dexter Spring	.....	.....	.....	72	.74	9.4	1.2	24	.....	2.6	25	30	82	198	Do.

a Suspended matter, 40.

b Suspended matter, 20.

c Bicarbonic acid, 42.

d Phosphate radicle (P<sub>2</sub>O<sub>5</sub>), 6.3.

e Total mineral solids.

f Iron.

Except in the Mosca-Hooper district, the waters of the valley are of a very good quality, having a maximum total solids of 240 and a minimum of 152 parts per million, as determined by complete analysis. These amounts are two to three times as great as those for the water of the Rio Grande at Del Norte, which contains 88.5 parts per million of total solids. The additional material in solution in the well waters is taken up by the water in its slow passage through the beds of sand and clay making up the water-bearing series.

W. P. Headden <sup>a</sup> has called attention to the unusually high percentage of silicic acid in the mountain waters of Colorado and of the San Luis Valley in particular. The following statement, showing the percentage of silicic acid in the total solids of several waters, is taken from his article:

*Percentage of silicic acid in total solids of San Luis Valley waters.*

Alamosa, Bucher well.....	46.9
Alamosa, Spriesterbach well.....	27.0
Alamosa, McNieland well.....	36.0
Del Norte, Rio Grande water.....	27.15
McIntire Springs.....	29.64

After confirmatory experimental treatment of powdered feldspar with distilled carbonated water, Headden concludes that the high percentage of silicic acid, combined and free, is normal for mountain waters in a region in which feldspar is an essential constituent of the rocks.

Perhaps the most noticeable constituent of the colorless waters, and to a lesser extent of the tinted waters as well, is sulphur. In the form of sulphates, as shown by the analyses, the greatest amount of sulphur is contained in the mill well at La Jara and in the McIntire Springs. Lesser amounts are shown by wells at Alamosa and Monte Vista and least of all by the tinted waters from the Mosca-Hooper district.

Sulphur is also present in the form of sulphureted hydrogen, which may be faintly or decidedly perceptible in most of the well waters of the valley, from both great and small depths. Upon oxidation, as the water is discharged from the well, the free sulphur is deposited in the stream flowing from the well as a gelatinous white precipitate upon vegetation or other objects, which are sometimes turned quite black. Occasionally the precipitate shows the long, delicate waving filaments of some form of sulphur-secreting bacteria, possibly *Thiothrix*.

In a single artesian well there was noticed a decided chalybeate taste and a reddish flocculent ferruginous precipitate in the stream flowing away from the well. This was in lot 1 of sec. 6, T. 43 N., R. 8 E.

<sup>a</sup> Am. Jour. Sci., 4th ser., vol. 16, 1903, pp. 169-184.

In the Mosca-Hooper district the waters are of a yellowish to dull-brown tint and have, for the valley, high contents of the alkalies and organic matter. These wells often give off gas more or less freely, some of them yielding enough to supply a cooking stove. The gas and the color are probably due to the decomposition of peaty moss which apparently grew in the swampy lake at a low stage. Some of the wells which have the deepest tinted waters do not yield gas. The water in wells yielding gas is always tinted, but usually only slightly so. The gas burns brightly with a yellow flame. It has a benzine-like odor, differing in this respect from natural gas elsewhere, which has an odor of sulphureted hydrogen. The amount of organic matter in the tinted waters, varying from 42 to 134 parts per million, is shown in the table of analyses on page 112.

The artesian water of this area is one of its most valuable assets. Cold, palatable, and free from probability of contamination, it must continue to be one of the chief factors in the salubrity of the valley. The tinted waters of the Mosca-Hooper district have a disagreeable taste to one not accustomed to them. The appearance of the water resembles that of rain that has collected in a hollow stump, and the taste is much what one imagines stump water to have. The slight odor of sulphureted hydrogen and the brownish color, together with the effect of imagination, are sufficient to explain this likeness, however. No case is known of injury from the use of the tinted waters, though it seems not unreasonable to suppose that the long-continued use of waters charged as highly with alkalies as these would entail some bad effect.

The colorless waters, containing a large percentage of silica ( $\text{SiO}_2$ ), when used in boilers form considerable scale, which is uniformly hard and tough; the tinted waters of the Mosca-Hooper district, containing less silica but high percentages of the alkaline carbonates, when so used are entirely free from scale but foam badly and also corrode and pit the boiler tubes. This damage is so great that the Denver and Rio Grande Railroad well at Hooper was abandoned for boiler use.

Though containing two to three times as much matter in solution as the ditch water, the clear artesian water along the west side of the valley is used, and has been for years, without injurious effect for irrigation of all crops. The tinted water, however, has a different effect. Along the margin of the streams flowing away from these wells there is always more or less alkali incrustation, and along one such stream, from a well in the NE.  $\frac{1}{4}$  sec. 27, T. 39 N., R. 10 E., a strip 10 to 15 feet wide was entirely bare of vegetation and there was much alkali along the margins. Reports as to the deleterious effects of the use of these waters for irrigation vary widely, as is to be expected in view of the fact that the degree to which the water is



tinted is not a conclusive guide to its alkalinity, inasmuch as it depends largely on peaty infusion. Thus some very dark waters may not show such injurious effects as a lighter-colored water that has a higher content of matter in solution. It seems to be pretty generally agreed, however, as the result of experience, that the dark water is nowhere as good as the ditch water and that in many places it is positively harmful and should always, if possible, be used in conjunction with ditch water. Its moderate use is likely to cause a "case-hardening" or the formation of a hard crust on the soil surface. In any event, even if one application is not injurious its continued use in subirrigation will surely impregnate the soil with alkali.

#### USES OF THE WATER.

The principal use of the artesian water is for household purposes, and most of the houses, even on many of the remote ranches, have running water piped into the kitchen and bathroom. Some wells, particularly in Monte Vista, which have not sufficient head to force water into the houses, yet flow freely at the ground level, are used to operate hydraulic rams, which throw a smaller stream to the desired height.

The artesian water is also especially desirable for stock purposes because of its moderate and constant temperature, which is high enough so that the wells remain open in winter; because of its continuity of supply without pumping or other care; and because of its freedom from contamination. Wells are bored here and there over the stock ranges in the valley by private persons or by neighborhood associations.

The waste flow from the household wells is either run into irrigating ditches or is used for the irrigation of gardens and truck patches. In the towns lawns, gardens, and shade trees are irrigated from the overflow of the wells. The surplus not so used runs into the gutters and is ordinarily collected into a ditch outside the town and used for field irrigation.

In certain sections of the valley the artesian water is an essential factor in irrigation. These regions can be recognized on the map by the close grouping of the wells and by their alignment in rows, ordinarily on the west side of the tracts of land, for this practice is largely confined to the west side of the valley, where the west side of any tract is the higher. Areas where many wells have been sunk for this purpose are (1) the region between Henry station and Bowen schoolhouse; (2) along Rock Creek; (3) in the neighborhood of Veteran schoolhouse; and (4) in the Warner neighborhood. In the first of these localities the wells were sunk for the purpose of irrigating grain, but in the last three chiefly for the purpose of irrigating native hay. Native meadows, since they are not cultivated from year to year,

have many little irregularities and hummocks which can not be irrigated from ditches. It is customary to irrigate such places, if of sufficient area, by a well sunk on the highest point.

In the Veteran and Warner neighborhoods the wells are used to irrigate both grain and hay, and their development was largely the result of the failure of ditch water. For the same reason many wells have been sunk toward the center of the valley in the Hooper and Mosca districts, where the supply of ditch water has been very inadequate in recent years. A recent development of the use of wells for irrigation is the construction of about fifty 6-inch wells in the vicinity of Henry station and westward as far as the Fountain neighborhood. These have in general been very successful.

The average well, if allowed to flow continuously, undisturbed, will wet an area of not more than one-half acre around the mouth of the well. The greater number of wells are used simply to supplement the flow in the ditches. The supply of ditch water early in the season is always sufficient to raise the "sub." Then, later in the season, when the ditch water fails, the ground being already wet, the steady flow of the artesian wells is of great value. Where wells are not to be used in connection with the ditch water a reservoir is a necessity, unless they are very large. In many parts of the valley, owing to the loose texture of the soil, reservoirs will absorb the entire flow of a well for a year before holding water. It is suggested that it would be a good plan to construct reservoirs in the fall and turn in the muddy flood water from the ditch until the bottom of the reservoir is thoroughly wetted and silted up.

It is hard to make a just estimate of the extent of the use of artesian water in irrigation, first, because of the fact, before stated, that the water is in many places turned into the ditches to supplement the ditch flow, and, second, because there is a tendency in the valley to underrate the extent of such use, lest an optimistic estimate should unfavorably affect desired legislation for storage reservoirs in the mountains. It is realized locally that further agricultural expansion depends on the construction of reservoirs to conserve the flood waters, and there is a concerted movement in that direction.

## WELLS.

### WELL DRILLING.

With a few exceptions the wells of the valley have been sunk by the hydraulic jet process. The exceptions are those which have been drilled through lava, mostly nonflowing wells. The deepest well in the valley, the No. 1 well of the San Luis Oil Company, 1,283 feet deep, was sunk by the hydraulic process, as were many others that reach 1,000 feet or more in depth. The individual drillers have their favorite forms of bits, and their own methods of "rotating" or

“driving” the casing, but the general method of sinking is the same here as elsewhere.

When the well has been sunk into the desired aquifer and the flow is reached, the pump is kept going for some time, a day or more in deep wells, with the object of stirring up the sand and carrying it up the well bore until a considerable cavity is made at the bottom of the well. Water can be delivered to the well only so fast as it can come through the sand walls of the cavity at the bottom of the well. The larger this cavity, the greater the contributing area of sand wall and the greater the volume of water. A new well naturally excavates for itself such a cavity and “throws sand” for several days, often with a pronounced increase of flow. But in the process large lumps may cave away from the clay above and entirely shut off the flow. It is the better plan, therefore, to pump out the cavity while the drill rig is set up over the well, so as to clear away the obstruction if the well chokes up. It is customary in the valley to case only to the first clay bed, through the superficial soil and gravel. This distance varies from 10 to 50 or rarely to 100 feet. Though inevitable, this practice of partial casing is much to be deplored.

Owing to the high freight rates, the item of casing in an average well costs more than the drilling. As long as a new well can be put down for the cost of casing the first one, most people of moderate means, at least in districts where the clay resists the caving fairly well, will prefer to take chances on the caving of the uncased well, especially where the wells are drilled for irrigation purposes as a last resort after successive failures of the ditch water and when immediate results are needed. Many wells, however, are cased down to the main flow that is used. The flow of such a well is affected only by increase in the number of wells, and can be shut off in winter time with impunity, whereas the uncased well is quite likely to cave within a year or so, particularly if plugged in winter. A large percentage of the wells in the valley have fallen off one-half or more in flow, principally through caving in. If caving takes place as a result of plugging the well, it usually happens when the plug is removed. While the well is open the rapid ascent of the water tends to carry to the surface and clear the well of any caved material as fast as it falls. When the well is plugged, however, the water in the bore and to a certain extent in the different aquifers assumes a uniform pressure. This uniformity of pressure has a tendency to favor the disintegration of the walls of the bore. The material breaking away settles downward through the still water in the bore and packs itself in the bottom. When the well is turned on again the amount of material packed in the bottom may be sufficient to cut off the lower flow. Again, the sudden shock of decrease of pressure when the well is suddenly opened by knocking out the plug has likewise a tendency to jar off pieces of the clay wall.

The cost of boring wells, owing to the similarity of the formations, is nearly uniform for similar sizes over the valley. The price of the completed well varies of course with the diameter and depth of the bore hole and the size and length of the casing. The price of casing also varies materially from time to time. The following statement gives the cost of a few typical wells in Alamosa, and the cost of others has been given in preceding pages.

*Cost of typical wells in Alamosa.*

Two-inch wells:	
230 feet deep, cased about 50 feet.....	\$55
460 feet deep, cased about 50 feet.....	101
600 feet deep, cased about 50 feet.....	135
735 feet deep, cased to the bottom.....	351
Three-inch wells:	
650 feet deep, cased about 50 feet.....	145
730 feet deep, cased about 50 feet.....	161
Town well, 5 $\frac{1}{8}$ inches in diameter:	
865 feet deep, cased to 852 feet.....	1,865

**APPROXIMATE MEASUREMENT OF FLOWING WELLS.**

Tables for determining the discharge of water from completely filled vertical and horizontal pipes were prepared a number of years ago by Prof. J. E. Todd, state geologist of South Dakota, who issued a private bulletin describing simple methods of determining quickly, with fair accuracy and with little trouble, the yield of artesian wells. The following tables and explanations relating to vertical and horizontal pipes are taken from this bulletin, with extensions by the present writer. The explanations and tables relating to the measurement in the partly filled horizontal and inclined pipes are from a paper by Charles S. Slichter.<sup>a</sup>

**FLOWS FROM FILLED PIPES.**

In determining the flow of water discharged through a pipe of uniform diameter all that is necessary is a foot rule, still air, and care in taking measurements. Two methods are proposed, one for pipes discharging vertically, which is particularly applicable before the well is permanently finished, and one for horizontal discharge, which is the most usual way of finishing a well.

The table on page 121 is adapted to wells of moderate size as well as to large wells. If the well is of a diameter not given in the table its discharge can without much difficulty be obtained from the table by remembering that, other things being equal, the discharge varies as the square of the diameter of the pipe. If, for example, the pipe

<sup>a</sup>In Contributions to the hydrology of the eastern United States, 1904: Water-Supply Paper U. S. Geol. Survey No. 110, 1905, pp. 37-42.

is one-half inch in diameter its discharge will be one-fourth of that of a pipe 1 inch in diameter for a stream of the same height. In a similar manner the discharge of a pipe 8 inches in diameter can be obtained by multiplying the discharge of the 4-inch pipe by 4.

In the first method the inside diameter of the pipe should first be measured, then the distance from the end of the pipe to the highest point of the dome of the water above, in a strictly vertical direction—*a* to *b* in the diagram (fig. 14). Find these distances in Table 1; the corresponding figure gives the number of gallons discharged each minute. Wind would not interfere in this case, if only the measurements are taken vertically.

The method for determining the discharge of horizontal pipes requires a little more care. First measure the diameter of the pipe as before; then from a point (*b*, fig. 14) 6 inches vertically below the

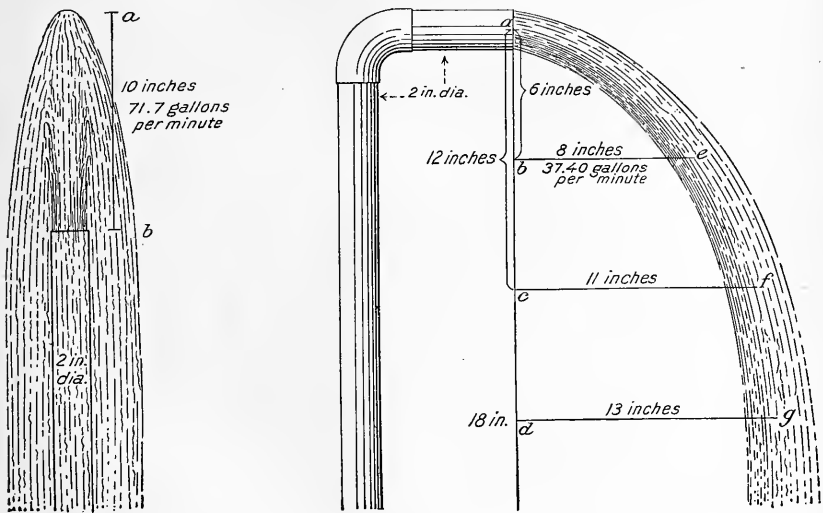

FIGURE 14.—Diagram illustrating flow from vertical and horizontal pipes.

center of the opening of the pipe, or some convenient point corresponding to it on the side of the pipe (*a*), measure strictly horizontally to the center of the stream (*b* to *e*). With these data the flow in gallons per minute can be obtained from Table 2. It will readily be seen that a slight error may make much difference in the result. Care must be taken to measure horizontally and also to the center of the stream. Because of this difficulty it is desirable to check the first determination by a second. For this purpose columns are given in the tables for corresponding measurements from a point 12 inches below the center of the pipe. Of course the same result should be obtained in the two measurements of the same stream. Wind blowing either with or against the water may vitiate results to an indefi-

nite amount; therefore measurements should be taken while the air is still.

Whenever fractions occur in the height or horizontal distance of the stream the number of gallons can be obtained by apportioning the difference between the readings in the table for the nearest whole numbers, according to the size of the fraction. For example, if the distance from the top of the pipe to the top of the stream in the first case is  $9\frac{1}{3}$  inches, one-third of the difference between the reading in the table for 9 and 10 inches must be added to the former to give the correct result.

One might suppose that when the flow of a well is measured by both methods the results should agree, but that is not the fact. In the vertical discharge there is less friction, and the flow is larger; so also in the second method differences will be found according to the length of the horizontal pipe used.

As pipes are occasionally set at an angle, it is well to know that the second method can be applied to them if the first measurement is taken strictly vertically from the center of the opening, and the second measurement from that point parallel with the axis of the pipe to the center of the stream, as before. The rates of flow in Table 2 are then applicable.

These tables are based upon a well-known formula of hydraulics. Experiment has shown that a margin of error is involved in the estimates when the height of the jet is less than 2 feet—that in such results there is 5 to 20 per cent or more of excess, which is greater the smaller the pipes and the lower the jets. But these are just the flows that can be most easily measured in a vessel of known size, and this method should always be resorted to when possible. The greater number of the larger wells flow from vertical pipes. Such a pipe may be so close to the ground that the water can not be caught in a receptacle; and not uncommonly it is surrounded by a reservoir, designedly or otherwise, so that it is inconvenient to measure by means of a vessel. For measuring the flow of such wells the tables will be found very convenient.

To convert gallons into cubic feet, divide by 7.5, or, more accurately, by 7.48.

A second-foot equals a flow of 448.8 gallons a minute, or 38.4 Colorado miner's inches. A flow of 100 Colorado miner's inches equals 2.6 second-feet. A flow of 100 Colorado miner's inches equals 1,170 gallons a minute; 1 Colorado miner's inch equals 11.7 gallons a minute.

TABLE 1.—For determining yield of artesian wells flowing from vertical pipes.

[Gallons per minute.]

Height of jet.	Yield from pipe with diameter of—					
	1 inch.	2 inches.	3 inches.	4 inches.	5 inches.	6 inches.
In.						
1	1.90	6.7	15.2	29.4	47.2	60.8
2	2.80	10.7	24.0	43.0	69.2	96.0
3	3.43	13.6	30.4	54.0	85.5	121.6
4	3.96	15.8	35.6	63.2	98.8	142.4
5	4.42	17.8	40.2	71.0	110.8	160.8
6	4.85	19.5	44.3	78.0	121.6	177.2
7	5.24	21.1	48.0	84.1	130.5	192.0
8	5.60	22.4	51.4	89.6	140.0	205.6
9	6.29	25.2	57.4	100.5	156.8	229.6
10	6.90	27.6	62.6	110.2	171.6	250.4
11	7.45	29.9	67.5	119.4	186.3	270.0
12	7.99	32.0	71.9	128.0	200.0	287.6
13	8.51	34.2	75.8	137.0	214.0	304.0
14	9.01	36.2	80.3	146.8	228.0	320.0
15	11.33	45.3	102.0	181.2	283.1	408.0
16	12.68	50.7	113.8	202.8	316.9	455.2
17	13.88	55.5	124.9	222.0	346.9	499.6
18	14.96	59.8	134.9	239.2	373.8	539.6
19	16.00	64.0	144.1	256.0	400.0	576.4
20	17.01	68.0	153.1	272.0	425.0	612.4
21	17.93	71.6	161.3	286.4	447.5	645.2
22	18.80	75.2	169.3	300.8	470.0	677.2
23	19.65	78.6	176.9	314.4	491.3	707.6
24	20.46	81.8	184.1	327.2	511.3	736.4
25	21.22	84.9	190.9	339.6	530.6	763.6
26	21.95	87.8	197.5	351.2	548.8	790.0
27	22.67	90.7	203.9	362.8	566.9	815.6
28	23.37	93.5	210.3	374.0	584.4	841.2
29	24.06	96.2	216.5	384.8	601.3	866.0
30	24.72	98.9	222.5	395.6	618.1	890.0
31	25.37	101.6	228.5	406.4	635.0	914.0
32	26.02	104.2	234.3	416.8	651.3	937.2
33	26.66	106.7	240.0	426.8	666.9	960.0
34	27.28	109.2	245.6	436.8	682.5	982.4
35	27.90	111.6	251.1	446.4	697.5	1,004.4
36	28.49	114.0	256.4	456.0	715.5	1,025.6
37	29.05	116.2	261.4	464.8	726.3	1,045.6
38	29.59	118.2	266.1	472.8	738.8	1,064.4
39	30.08	120.3	270.4	481.2	751.9	1,081.6
40	30.55	121.9	274.1	487.6	761.9	1,096.4
41	30.94	123.4	277.6	493.6	771.3	1,110.4
42	34.1	136.3	306.6	545.2	851.9	1,226.4
43	39.1	156.5	352.1	626.0	978.1	1,408.4
44	43.8	175.2	394.3	700.8	1,095.0	1,577.2
45	48.2	192.9	434.0	771.6	1,205.6	1,736.0
46	51.9	207.6	467.0	830.4	1,297.5	1,868.0
47	55.6	222.2	500.0	888.8	1,388.8	2,000.0
48	58.9	235.9	530.8	943.6	1,474.4	2,123.2
49	62.2	248.7	559.5	984.8	1,554.4	2,238.0
50	65.1	260.4	585.9	1,041.6	1,627.5	2,343.6
51	68.0	272.2	612.5	1,088.8	1,701.3	2,450.0

TABLE 2.—For determining yield of artesian wells flowing from horizontal pipes.

[Gallons per minute.]

Horizontal length of jet.	1-inch pipe.		2-inch pipe.		3-inch pipe.	
	6-inch level.	12-inch level.	6-inch level.	12-inch level.	6-inch level.	12-inch level.
<i>In.</i>						
6	7.01	4.95	27.71	19.63	62.35	44.17
7	8.18	5.77	32.33	22.90	72.74	51.53
8	9.35	6.60	36.94	26.18	83.12	58.91
9	10.51	7.42	41.56	29.45	93.51	66.26
10	11.68	8.25	46.18	32.72	103.91	73.62
11	12.85	9.08	50.80	35.99	114.30	80.98
12	14.02	9.91	55.42	39.26	124.70	88.34
13	15.19	10.73	60.03	42.54	135.07	95.72
14	16.36	11.56	64.65	45.81	145.46	103.07
15	17.53	12.38	69.27	49.08	155.86	110.43
16	18.70	13.21	73.89	52.35	166.25	117.79
17	19.87	14.04	78.51	55.62	176.65	125.15
18	21.04	14.86	83.12	58.90	187.02	132.53
19	22.21	15.69	87.74	62.17	197.42	139.88
20	23.37	16.51	92.36	65.44	207.81	147.24
21	24.54	17.34	96.98	68.71	218.21	154.60
22	25.71	18.17	101.60	71.98	228.60	161.96
23	26.88	18.99	106.21	75.26	238.97	169.34
24	28.04	19.82	110.83	78.53	249.37	176.69
25	29.11	20.64	115.45	81.80	259.76	184.05
26	30.38	21.47	120.07	85.07	270.16	191.41
27	31.55	22.29	124.69	88.34	280.55	198.77
28	32.72	23.12	129.30	91.62	290.93	206.15
29	33.89	23.95	133.92	94.89	301.32	213.50
30	35.06	24.77	138.54	98.16	311.72	220.86
31	36.23	25.59	143.16	101.43	322.11	228.22
32	37.40	26.42	147.78	104.70	332.51	235.58
33	38.57	27.25	152.39	107.98	342.88	242.96
34	39.64	28.08	157.01	111.25	353.27	250.31
35	40.45	28.64	161.63	114.52	363.67	257.67
36	41.60	29.46	166.25	117.79	374.06	265.03
Continue by adding for each inch--						
	1.15	0.82	4.62	3.27	10.39	7.36

The flow in pipes of diameters not given in the table can easily be obtained in the following manner:

For $\frac{1}{2}$ -inch pipe, multiply discharge of 1-inch pipe by.....	0.25
For $\frac{3}{4}$ -inch pipe, multiply discharge of 1-inch pipe by.....	0.56
For $1\frac{1}{4}$ -inch pipe, multiply discharge of 1-inch pipe by.....	1.56
For $1\frac{1}{2}$ -inch pipe, multiply discharge of 1-inch pipe by.....	2.25
For 3-inch pipe, multiply discharge of 2-inch pipe by.....	2.25
For 4-inch pipe, multiply discharge of 2-inch pipe by.....	4.00
For $4\frac{1}{2}$ -inch pipe, multiply discharge of 2-inch pipe by.....	5.06
For 5-inch pipe, multiply discharge of 2-inch pipe by.....	6.25
For 6-inch pipe, multiply discharge of 2-inch pipe by.....	9.00
For 8-inch pipe, multiply discharge of 2-inch pipe by.....	16.00

## MEASUREMENT OF FLOWS FROM PARTLY FILLED PIPES.

From Table 3 below it should be possible, if the wind is not blowing too hard, to determine the flow from a partly filled pipe with an error probably not exceeding 10 per cent. This error is no greater than the fluctuation of the flow due to the daily variations of the barometric pressure in most wells. The results in extreme cases, such as a



$\frac{1}{4}$ -inch stream in a 6-inch pipe are, of course, still less accurate, and actual measurement by collecting the water in a vessel of definite capacity should be resorted to if possible.

TABLE 3.—For estimating the discharge from partly filled horizontal or sloping pipes.

Fractional part of diameter of pipe not occupied by water. [Obtained by dividing A D by A B in fig. 1.]	Discharge expressed as percentage of discharge from full pipe, same size.	Fractional part of diameter of pipe not occupied by water. [Obtained by dividing A D by A B in fig. 1.]	Discharge expressed as percentage of discharge from full pipe, same size.
0.05	0.98	0.55	0.44
.10	.95	.60	.37
.15	.91	.65	.31
.20	.86	.70	.25
.25	.80	.75	.20
.30	.75	.80	.14
.35	.69	.85	.092
.40	.63	.90	.054
.45	.55	.95	.015
.50	.50	1.00	.000

To estimate the discharge from a partly filled horizontal or sloping pipe, first estimate the discharge from full pipe of the same size by means of Table 2.

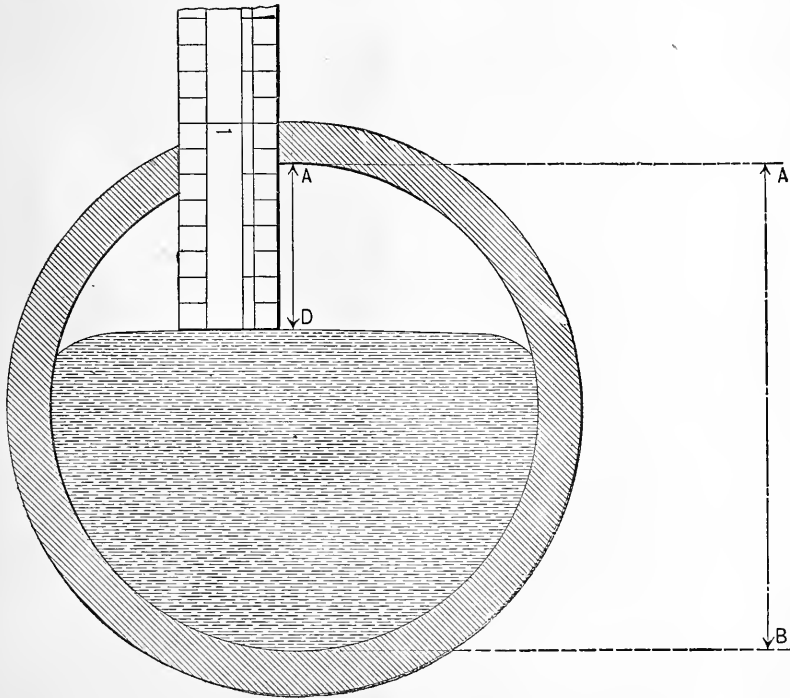

FIGURE 15.—Method of measuring partly filled pipes.

Next measure with a foot rule the dimension A D (fig. 15) of the empty portion of the cross section of the pipe. Divide this by the

inside diameter of the pipe, which will give the fractional part of the diameter that is occupied by the empty part of the pipe. In Table 3 find in the first column the number nearest to the above quotient. Opposite this number will be found the percentage of the discharge of the full pipe that the partly filled pipe is yielding. It is sufficient to measure the distance A D to the nearest eighth of an inch, or at most to the nearest sixteenth of an inch.

Suppose that a 2-inch horizontal pipe has a length of jet of 13 inches at 6-inch level. From Table 2 this would represent a discharge of 60 gallons per minute from the full pipe. Suppose that the distance A D is five-eighths of an inch and A B is 2 inches, or sixteen-eighths of an inch. Dividing 5 by 16 gives 0.31. In the first column of Table 3 we find 0.30, the nearest to 0.31, and opposite 0.30 in the second column of the table appears 0.75. The discharge from the partly filled pipe is therefore  $60 \times 0.75 = 45$  gallons per minute.

# INDEX.

A.	Page.		Page.
Acknowledgments to those aiding	7-8	Beckwith well, description of	101
Adams ranch well, description of	61-62	record of	101
record of	61	Bibliography of region	8-9
Agriculture, conditions of	25-29	Black Canyon, glaciation on	38
Alamosa, wells at and near	55, 57-60	Blanca farm well, description of	60
wells at and near, location of, map showing	58	water of, analysis of	112
records of	58-60	Blanca Peak, fans near	10
water of, analyses of	112, 113	glaciation on	38
Alamosa Creek, fan of	10	rocks of	35-36
glaciation on	33	section from, figure showing	45
reservoir on	18	view of	10
valley of, geology of	30-31	Bluffs, occurrence of	11
section of	31	Bowen, wells near	97-98, 115
view on	30	wells near, record of	97
Alamosa formation, age of	46	Braiden well, description of	94
deposition of	52-53	Bucher well, description of	55, 57
fossils of	47	water of, analysis of	111, 112, 113
occurrence and character of	40-47	view of	40
sections of	40-43	Building stone, occurrence and character of	30
view of	40	C.	
Alamosa Milling and Elevator Co.'s well,		Calkins wells, description of	80
description of	59	records of	80
water of, analysis of	112	Capulin, wells near	95-97
Alkali, injury from	26, 27-28	wells near, records of	95, 96
location of, map showing, character of	28	Carnero, wells near	74
Alkali-lake deposits, occurrence and character of	50	Carpenter, L. G., cited	49, 56, 57-58
Alluvial fans. <i>See</i> Fans, alluvial.		Cat Creek, fan of	10
Alluvium, occurrence and character of	49	glaciation on	33
Altitudes, table of	11-12	valley of, geology of	31
Ammonia, amount of, in well waters	111	view on	32
Andersen well, description of	83-84	Centennial ditch, flow of	19
water of, analysis of	112	Center, wells near	71-73
Antelope Springs, description of	103	wells near, location of, map showing	72
Antonito, view near	30	record of	73
wells near	92-93	water of, salts in	111
records of	92-93	Chamberlain Hot Springs, description of	103-104
water of, analysis of	112	pumping near	21
Artesian basin (San Luis), capacity of	56-57	view at	102
characteristics of	105-110	Chanvenet, R., analysis by	112
description of	54-55	Chicago and San Luis Oil Co.'s well, description of	82
water of, source of	55-56	record of	43
supply of	56	Chitton well, record of	84
Artesian system, general requisites of	54	Clark well, description of	87-88
Atkinson ranch well, description of	68	gas in	87
Austin ranch well, description of	68	record of	88
		view at	88
B.		Climate, description of	22-25
Baca grant, wells on	79, 100	Colorado, index map of	9
Baldy, wells near	100-101	Conejos, rainfall and temperature at	22-24
Baldy Peak, rocks of and near	35-36	Conejos County Oil Co.'s well, description of	95
Bear Creek, glaciation on	38	record of	95
Becker well, description of	67	Conejos Range, geology of	29-34
record of	67	section from, figure showing	45

	Page	G.	Page.
Conejos River, fan of.....	10-11	Gaging stations, location of.....	12-13
springs on.....	101-102	Garnett, rainfall and temperature at.....	22-24
Costilla ditch, flow of.....	19	Garrison Mill and Elevator Co.'s well, description of.....	85
Crestone, wells near.....	100	record of.....	85
Crops, character of.....	26-27	water of, analysis of.....	112
Cross, Whitman, work of.....	30	Gas, occurrence of.....	81-82
Culebra Range, glaciation in.....	38	Geography, description of.....	9-29
rocks of.....	37	Geologic history, outline of.....	50-54
D.			
Dall, W. H., fossils identified by.....	47	Geology, description of.....	29-54
Davidson well, description of.....	78	Glaciation, occurrence and character of:	
Dead Man Creek, well on.....	100	relation of, to fans.....	46
Dearborn Drug & Chemical Co., analyses by.....	112	figure showing.....	46
Del Norte, discharge at.....	13, 16, 20	Goodall well, description of.....	59
wells near.....	98	record of.....	59
water of, analysis of.....	113	H.	
Del Norte canal, flow of.....	10, 19	Hansen Bluff, description of.....	11
Denver and Rio Grande wells, description of.....	58,	section at.....	40-41
record of.....	76, 86, 93,	view of.....	40
water of, analysis of.....	58, 86, 93, 100	Hansen ranch well, description of.....	67
Dexter Spring, description of.....	102	Harvey ranch well, description of.....	96-97
water of, analysis of.....	111, 112	Hayden, F. V., cited.....	32-33, 36, 39, 48
Drainage, description of.....	12	Headden, W. P., analysis by.....	112
Dunn ranch well, description of.....	99	cited.....	50, 111, 113
E.			
East ranges, glaciation of.....	37-38	Henry, wells near.....	60-62, 115
stratigraphy and structure of.....	36-37	wells near, records of.....	61-62
Elevations, table of.....	11-12	Hess well, description of.....	73
Elliott well, water of, salts in.....	111	record of.....	73
Embudo, discharge at.....	14, 16-18	Hinton, R. J., cited.....	49
Emmons, S. F., cited.....	35	Hirst well, description of.....	59
Empire canal, flow of.....	19	Hooper, wells near, location of, map showing.....	85-88
Empire farm wells, description of.....	60-61	records of.....	85-86, 88
records of.....	61	water of, analyses of.....	112
view of.....	60	Hot Creek Springs, description of.....	104
Endlich, F. M., cited.....	36-37, 39-40, 48, 49, 53	Hubbard well, description of.....	63
Engle, N. Mex., reservoir at.....	19	record of.....	63
Eskridge well, record of.....	96	Hunt Springs, description of.....	102-103
Espinosa well, description of.....	74	view of.....	88
view of.....	74	Hydrography, description of.....	12-22
F.			
Fans, alluvial, occurrence of.....	10, 48-49	I.	
relation of, to moraines.....	46	Irrigation, extent of.....	19-22
figure showing.....	46	methods of.....	27-29
relation of, to water beds.....	45-46	progress of.....	25-26
Farmers' Union canal, flow of.....	10, 19	relation of, to Rio Grande.....	15-18
Fellows, A. L., cited.....	17	use of wells for.....	56-57, 115-116
Field work, date of.....	7	<i>See</i> Subirrigation.	
Fleck, Herman, cited.....	50	J.	
Flow, variations in.....	105-108	Jacobs ranch, description of.....	89-90
Flowing wells, detailed descriptions of.....	57-92	gas on.....	90
Flumes, canvas, use of.....	21-22	Johansen ranch well, description of.....	69
Fort Garland, rainfall and temperature at.....	22-25	Johnston well, description of.....	74
rocks near.....	39	record of.....	74
wells near.....	101	Jordan well, description of.....	99
record of.....	101	K.	
Fort Massachusetts, rainfall at.....	25	Kennicott Water Softener Co., analysis by... ..	112
Fountain, wells near.....	62-63	Kinch well, description of.....	62
wells near, records of.....	62-63	record of.....	62
Fowler, Jacob, cited.....	52	view of.....	60
Frazee ranch well, description of.....	77	Kinney ranch, wells on.....	88-89
Fred well, record of.....	96	Knapp well, description of.....	95
Fritz Emperius well, description of.....	59	record of.....	95

L.	Page.	Page.	
La Garita, wells near.....	99	Mosca Milling and Elevator Co.'s well, de- scription of.....	83
La Jara, rainfall and temperature at.....	22-24	water of, analysis of.....	112
wells near, description of.....	63-65	Mosca Pass, sand dunes near.....	40
location of, maps showing.....	64, 65	Myers well, description of.....	67
records of.....	63, 65	record of.....	67
water of, analysis of.....	112	N.	
La Jara Creek, fan of.....	10	Nash well, description of.....	79
La Jara Milling and Elevator Co.'s well, de- scription of.....	64	record of.....	79
water of, analysis of.....	112	Navin ranch well, description of.....	74
Lambert well, description of.....	64-65	view of.....	74
record of.....	65	Newcomb ranch well, record of.....	41-42
Lavas, effusion of.....	51, 53-54	Newcombe well, description of.....	96
Lee, W. T., cited.....	34, 37, 53	Newsom ranch wells, description of.....	60
Literature, list of.....	8-9	record of.....	60
Location of San Luis Valley.....	9	Norland well, description of.....	64
map showing.....	9	O.	
Lockett, wells of.....	73-74	Oil, occurrence of.....	82
wells of, records of.....	73, 74	Orient, springs at, water of, analysis of.....	112
Los Mogotes, discharge near.....	15	Ottaway well, description of.....	62
Los Sauces, springs at, water of, analyses of.....	112	record of.....	62
wells near.....	67-68	Outcault well, description of.....	69
records of.....	67	P.	
Lovett well, record of.....	96	Painted Rock Bluff, description of.....	31
M.		view of.....	32
McDaniel well, description of.....	94	Palmer ranch wells, description of.....	95
record of.....	94	Parma, wells near.....	68-69
McIntire Springs, description of.....	101-102	wells near, record of.....	68
flow of.....	17	Parrish wells, description of.....	91-92
view at.....	102	record of.....	92
water of, analysis of.....	111, 112, 113	Pipes, flow from.....	118-124
McNieland well, water of, ammonia in.....	111	Pitzer ranch well, description of.....	100
water of, silicic acid in.....	113	Powell, J. W., on Colorado irrigation.....	15-16
Manassa, wells near.....	93-95	Population, character of.....	25-26
wells near, records of.....	94, 95	Prairie ditch, flow of.....	10, 19
Map, index, of Colorado.....	9	Precipitation, records of.....	22-25
Map of San Luis Valley.....	Pocket.	Pumping plants, plan of, figure showing.....	21
description of.....	10	use of.....	20-21
Medano ranch, dunes on, view of.....	48	Q.	
wells on, description of.....	80	Quality of water, records of.....	111-115
Medano Springs, description of.....	103	Quaternary deposits, occurrence and char- acter of.....	47-50
Mirage, wells near.....	78	R.	
Mitchell ranch well, description of.....	61	Rainfall, records of.....	22-25
Moffat, wells near.....	76-77	Recent deposits, occurrence and character of.....	47-50
wells near, location of, map showing.....	77	Relief, description of.....	10-12
records of.....	77	Reservoirs, natural, occurrence of.....	18
water of, analysis of.....	112	Reservoir sites, occurrence of.....	18-19
Monte Vista, rainfall and temperature at.....	22-24	Richfield, wells near, location of, map showing.....	65
rocks near.....	32	Rio Grande, course of.....	49
wells near.....	69-71, 98	discharge of, at Del Norte.....	13, 16, 20
location of, map showing.....	70	at Embudo.....	14, 16-18
record of.....	69, 71	at State Bridge.....	14, 16-17
water of, analysis of.....	111, 112	near Los Mogotes.....	15
Monte Vista canal, flow of.....	19	effect of San Luis irrigation on.....	15-18
Monte Vista Milling Co.'s well, description of.....	69	fan of.....	10, 45-46
record of.....	69	irrigation from.....	20
water of, analysis of.....	112	loss of water in sauds of.....	15, 55
Mosca, wells near.....	82-85	reservoirs on.....	18-19
wells near, location of, map showing.....	83	water of, silicic acid in.....	113
record of.....	84	temperature of.....	109
water of, analyses of.....	112		
Mosca-Hooper region, oil and gas in.....	81-82		
water of, character of.....	81-82, 114		
effects of.....	114-115		
wells of.....	81-90		

	Page.		Page.
Rock Creek, cirque on, view of	10	Subirrigation, methods of	27
glaciation on	33	pumping for	20
valley of, geology of	31-32	relation of, to well flow	105
wells in	71, 115	Sulphur, occurrence of, in well water	113
Russell Springs, description of	102	Swede Corners, wells near	75-76
S.		wells near, records of	75
Salts, total of, in well waters	111	T.	
Sand dunes, occurrence of	40, 47-48	Temperature of air, records of	22-23
view of	48	Temperature of well water, variations in	108-110
Sanford, wells near	66-67	Tinted water. <i>See</i> Mosca-Hooper region.	
wells near, location of, map showing	66	Tobler well, description of	78
record of	67	Todd, J. E., on flow of wells	118
Sangre de Cristo Range, age of	53-54	Topography, description of	10-12
rocks of	34-37	U.	
San Isabel, wells near	78-79	Underflow, pumping of	20-21
wells near, record of	79	Underground waters, account of	54-116
San Luis, rainfall and temperature at	22-24	Ute Creek, fan on	39
rocks near	37	rocks on	36
wells near	90-92	V.	
location of, map showing	90	Valley, rocks of	39-50
San Luis canal, flow of	19	Valley View Hot Springs, description of	104
San Luis Creek, drainage of	12	water of, analysis of	112
fan of	11	Van Diest, E. C. and P. H., cited	37
valley of, section of	44-46	Vegetation, character of	26
section of, figure showing	45	Veteran, wells near	74, 115-116
San Luis Hills, location of	9	Villa Grove, rocks near	34
rocks of	38-39	wells near	99-100
San Luis Oil Co., well of	116	Von Schultz & Low, analyses by	112
San Pedro Mesa, rocks of	32, 38, 39	W.	
Santa Fe formation, deposition of	51-52	Wagon Wheel Gap, rainfall and temperature	
occurrence and character of	32-33, 39-40	at	22-25
view of	30	Warner, wells near	76, 115-116
Saguache, rainfall and temperature at	22-24	wells near, section of	76
rocks near	32	Washington Springs, description of	103
wells near	99	Waters, underground, account of	54-116
Saguache Creek, fan of	11	Watson well, description of	85
Sawatch Range, geology of	29-34	record of	85
Schwartz ranch well, description of	60	Wells, casing of	117
Seasons, variation of flow with	105	drilling of	116-118
variation of temperature with	110	cost of	118
Settlement, order of	25-26	failure of	105-107
Shellabarger well, description of	77	flow of	105-108
Silicic acid, percentage of, in well waters	113	measurement of	118-124
Slichter, C. S., cited	118	grouping of	105
Smith well, description of	91	interference of	106-107
record of	91	irrigation from	56-57, 115-116
Soda Lake, view of	32	water of, quality of	111-115
Sodium carbonate, deposits of	50	temperature of	108-110
Soil, exhaustion of	25-26	uses of	115-116
Spriesterbach well, description of	59	<i>See also particular wells; Flowing wells;</i>	
record of	41	Nonflowing wells.	
water of, silicic acid in	113	Western ranges, glaciation in	33-34
Spring Creek, description of	102	rocks of	29-32
Springs, occurrence of	38, 101-104	age of	32-33
supply from	17-18	<i>See also Conejos Range; Sawatch Range.</i>	
Star ranch well, description of	88	Wilkins well, description of	60
State bridge, discharge near	14, 16, 17	Willow Creek, park on, view of	34
Stevenson, J. J., cited	52-53	rocks on	35
Stewart ranch well, description of	68	view on	36
Stock raising, progress of	27	Worcester ranch well, description of	60
Strauss well, description of	98	Woodhouse well, description of	74
Steam gagings, results of	12-15		
"Sub." <i>See</i> Subirrigation.			
Subirrigation, injurious effects of	27-29		

# TOPOGRAPHIC MAP OF SAN LUIS VALLEY, COLORADO

By C. E. SICKENDUL

Scale  
1:62,500  
1 inch = 1 mile  
1 centimeter = 0.4 inch

Horizontal accuracy - 200 feet  
Vertical accuracy - 100 feet

Copyright 1900 by the United States Geological Survey

### LEGEND

- Contour interval - 20 feet
- Flowing well
- Non-flowing well
- Area of flowing water
- Point of gage high
- Limit of submergence

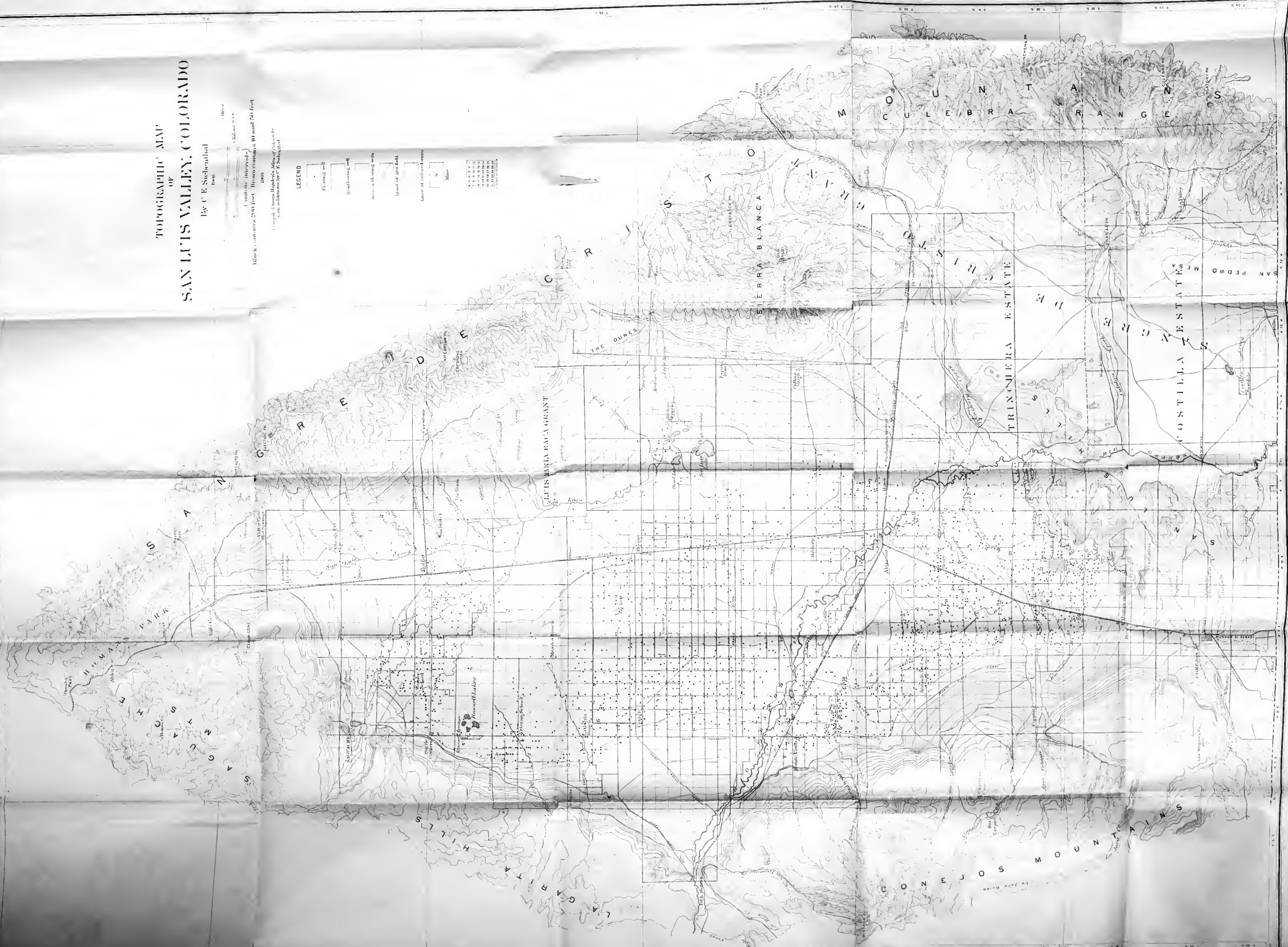











LIBRARY OF CONGRESS



0 019 953 828 7